

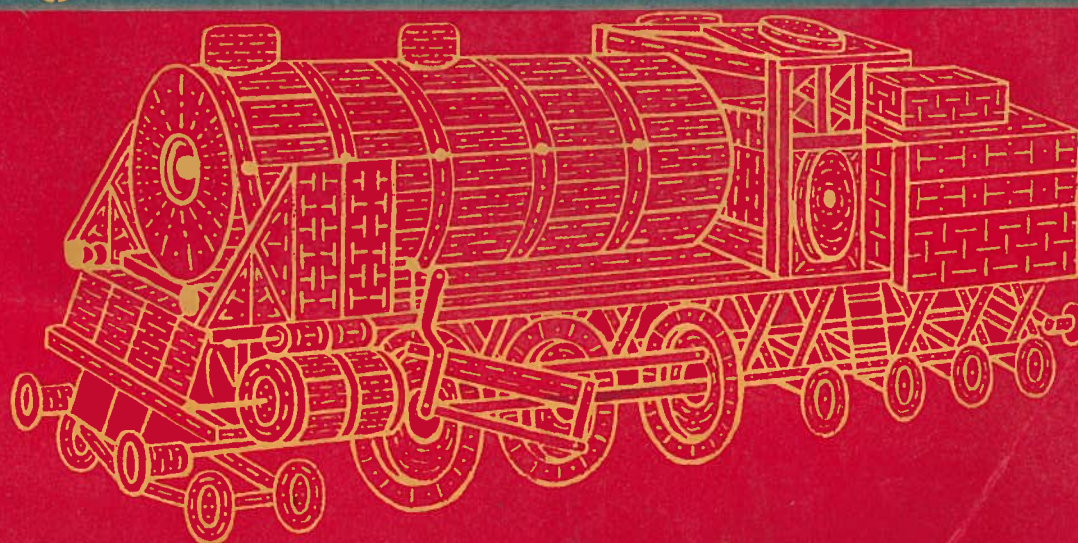

TECHNIC



JOUET EDUCATIF PRODUIT PAR **UNICA** COURTRAI · BELGIE
OPVOEDEND SPEELGOED VOORTGEBRACHT DOOR **KORTRIJK · BELGIE**

TECNIC

UNICA s.p.r.l.
COURTRAI - Belgique

TECNIC

La maison spécialisée en jouets depuis toujours, offre présentement au jeune inventeur, ingénieur, constructeur, électricien, mécanicien, technicien en général :

Qualité. -- Science. -- Amusement.

Tecnic n'est pas un jouet mais un amusement instructif pour tous les âges. Ses possibilités de création sont pratiquement illimitées.

Conseils aux débutants.

Chaque boîte comporte les outils nécessaires au montage des modèles les plus divers.

Nous attirons l'attention de nos jeunes techniciens sur le fait que "TECNIC" ne s'assimile à aucun jeu ressemblant du fait que :

1° les diamètres des vis et axes sont différents.

2° les écartements dans nos perforations n'ont rien de commun avec les distances des perforations pratiquées dans les autres jeux.

Réalisation des modèles du catalogue

Chaque cliché du catalogue vous donne une image nette et précise du modèle achevé, que vous commencerez par imiter. Le nombre des pièces nécessaires pour chaque objet est donné à côté du modèle. Lorsque vous aurez achevé la réalisation des modèles du catalogue, et acquis l'habitude et le plaisir de travailler avec "TECNIC"; alors il vous sera aisé de commencer la réalisation de vos propres inventions. La facilité d'assemblage, le nombre multiple des glissières dans chacune des pièces "TECNIC" vous permettront la création de pures merveilles techniques.

Vous perfectionnerez continuellement vos propres inventions pour l'émerveillement de vos amis et entourages.

Réalisations complémentaires.

Bien que chacune de nos 9 boîtes de base constitue par elle-même un jeu complet, nos jeunes techniciens pourront agrandir le choix de leurs pièces, par l'achat des boîtes complémentaires. Ainsi le propriétaire d'une boîte 3 pourra arriver à posséder une boîte 4, par l'addition de la boîte 3-4, la boîte 4+4-5 donne la boîte 5, et ainsi de suite.

Par contre, pour les amateurs désireux de se créer une collection de pièces "TECNIC" en dehors des 9 boîtes standard, toutes les autres pièces nécessaires sont en vente dans les magasins vendant "TECNIC"

Perfectionnements divers

Engrenages, manchons d'accouplement, tringles spéciales, rails, éclisses, moteurs sont vendus à des prix modiques aux amateurs de "TECNIC".

Recommandations importantes

Notre Firme UNICA s.p.r.l. Dépt. TECNIC à Courtrai-Belgique se fera un plaisir de renseigner par écrit, les amateurs de Tecnic qui désireront nous consulter, nous demander un conseil, éventuellement nous exposer leurs desiderata. En cas de réclamation justifiée, la réponse la plus favorable peut être attendue par nos techniciens et satisfaction entière leur sera toujours accordée.

PRIX DE VENTE IMPOSÉS.

TECNIC

UNICA p.v.b.a.
KORTRIJK - België

TECNIC

Het Huis, sedert lange jaren gespecialiseerd in speelgoed, biedt thans aan de jonge uitvinder, ingenieur, bouwkundige, technisch ingenieur, mechanicus, electriciër, technicus in 't algemeen:

Kwaliteit. -- Wetenschap. -- Vermaak.

Tecnic is geen speelgoed, maar een leerrijk vermaak voor alle leeftijden. De verwezenlijkingen met Tecnic zijn onbegrensd.

Raadgevingen aan de beginnelingen.

Ieder doos bevat de nodige gereedschappen vereist tot het vervaardigen van de meest verscheidene modellen.

Wij trekken de aandacht van onze jeugdige technici op het feit dat "TECNIC" zich met geen ander spel kan aanpassen, om volgende redenen:

1° de diameters der vijzen en assen zijn verschillend.

2° de afstanden der hartlijnen van onze doorboringen hebben niets gemeen met de afstanden der hartlijnen van de andere spelen.

Uitvoering der modellen volgens catalogus.

Ieder afdruksel in de catalogus geeft U een juist en net beeld van het afgewerkt model dat U wenst na te maken. Het aantal nodige stukken voor ieder model is onderaan van dit aangegeven. Wanneer U de verwezenlijking der modellen volgens catalogus zult afgewerkt en de gewoonte en het plezier zult verworven hebben met "TECNIC" te werken, zal het U licht vallen uw eigen uitvindingen te verwezenlijken. De gemakkelijker waarmee onze stukken kunnen samengevoegd worden door het groot aantal sleufgaten zullen U echte Technische wonderen doen voortbrengen. Uw vindingrijkheid zal met den dag toenemen tot grote verbazing en genoegen van uw vrienden en kennissen.

Aanvullende verwezenlijkingen.

Niettegenstaande dat ieder van onze 9 basisdozen op zich zelf een volledig spel vormt zullen onze jeugdige technici een grotere keus van stukken vinden in het aankopen van aanvullende dozen en losse stukken. De eigenaar van een doos 3 zal zich kunnen een doos 4 aanschaffen door den aankoop van de doos 3-4. De doos 4+4-5 geeft een doos 5, enz.

De liefhebbers die een collectie TECNIC-losse stukken zouden wensen aan te schaffen, kunnen deze verkrijgen in de magazijnen die "TECNIC" verkopen.

Allerhande verbeteringen.

Rechte en konische tandwielen, kettingen en kettingwielen, aandrijfveren, koppelingssystemen, schroefassen, riemschijven, trappenschijven, kogellagers, rails, klinkmechanismen, motoren 15 à 30 W, transformatoren, lamphouders en andere elektrische uitrustingen zullen binnen kort aan geringe prijzen aan de liefhebbers van TECNIC verkocht worden.

Voornamen aanbevelingen.

Onze firma UNICA p.v.b.a. Afd.: "TECNIC" Kortrijk-België zal met groot genoegen de liefhebbers van "TECNIC" die ons zullen willen raadplegen of bij ons de ene of andere inlichtingen inwinnen, schriftelijk beantwoorden.

Ingeval van geïronde klachten zullen zij voldoening krijgen.

VASTGESTELDE VERKOOPPRIJZEN.

TECNIC

UNICA Ltd.
COURTRAY - Belgium

TECNIC

The firm specialized since years in toys, offers at present to the young inventor, engeneer, constructor, electrician, mechanician, technician in general: **TECNIC.**

Quality. -- Science. - Amusement.

Tecnic is not a toy, but an instructif amusement for all ages. Its possibilities of creation are practically illimited.

Advice to Beginners.

Each box contains the necessary tools to mount the most various models.

We call the attention of our young technicians to the fact that "TECNIC" can not be adapted to any other game, for the following reasons :

- 1) The diameters of screws and axles differ.
- 2) The distances in our perforations have nothing in common with those of other games.

Realization of the models of the Catalogue.

Each drawing of the catalogue gives you an accurate and clear image of the complete model you are going to imitate. The number of parts of each object is printed next to every model. When you will have finished mounting the models of the catalogue and you will have acquired the habit and the pleasure of working with "TECNIC" it will be easy for you to achieve your own inventions. The facility of assembling these parts and the great number of their slides, will enable you to accomplish real technical wonders. You will keep on perfecting your own inventions to the amazement of your friends and acquaintances.

Additional Inventions.

Although every one of our 9 basis boxes constitutes by itself a complete game, our youthful technicians will find a greater choice of parts when buying additional boxes. The proprietor of box 3 will be able to pass from 3 to 4, when buying the differential box 3-4; box 4 gives with the differential box 4-5 a complete box 5, and so on.

Besides, amateurs desirous to acquire a collection of parts, which does not belong to the 9 standard boxes, can obtain them from any "TECNIC" dealer.

Various Improvements.

Gears, sliding sleeves, special rodes, rails, joints can be obtained at low prices for "TECNIC" amateurs.

Important Recommendations.

"UNICA" department "TECNIC" Courtray-Belgium will gladly give written informations to "TECNIC" amateurs who wish to consult us, to ask our advice or eventually expose their desiderata. In case of founded complaint they will get satisfaction.

FIXED SELLING PRICES.

TECNIC

UNICA soc.
COURTRAI - Belgica

TECNIC

La Casa, desde largo tiempo especializa da en la fabricación de juguetes entrega la presente oferta à cada joven inventor, ingeniero, constructor, électricista, mecànico, técnico en general

Calidad. -- Ciencia. -- Recreación.

Tecnic no ès un juguete, ès un pasatiempo instructivo para cada edad. Son pràcticamente ilimitadas sus posibilidades de creación.

Consejos a los debutantes.

Cada cajeta contiene las herramientas necesarias para el montaje de modelos más varios.

Llamamos la atención de nuestros jóvenes técnicos en el hecho que no semeja "TECNIC" ningun juego semejante pues.

1º) los diametros de las roscas y de los ejes son diferentes.

2º) las distancias en nuestras perforaciones no tienen ninguna analogia con las de perforaciones practicadas en otros juegos.

Realizaciones de los modelos del catálogo.

Cada cliché del catálogo da una imagen neta y precisa del modelo acabado, que empezaran imitando los jóvenes técnicos. La cantidad de piezas necesarias para cada objeto queda indicada al lado del modelo. Después de acabada la realización de los modelos del catálogo y adquiridos el costumbre y el gusto de trabajar con "TECNIC", tendran los jóvenes técnicos facilidad de empezar sur propias invenciones. La facilidad de ensamblaje, la cantidad multiple de ranuras en cada pieza de "TECNIC" posibilitaran la creación de maravillas puras técnicas.

Pueden nuestros jóvenes técnicos mejorar constantemente sus propias invenciones, maravillando de este modo à sus amigos y acompañantes.

Demàs realizaciones.

Aunque constituàscado de nuestras ocho cajetas por si mismo un juego completo, pueden nuestros jóvenes técnicos aumentar la selección de sus piezas, comprando cajetas complementarias. El propietario de una cajeta 3 podrá llegar asi à la posesion de una cajeta 4, por adición de la cajeta 3-4 y consecutivamente, la cajeta 4+4-5 da la cajeta 5, etc.

En cambio, por lo que toca à los diletantes deseando crearse una colección de piezas "TECNIC" fuera de los 9 cajetas tipas, todas las otras cajetas se venden en los almacenes vendiendo "TECNIC".

Varios perfeccionamientos.

Engranajes, manguitos de coplamiento, varillas especiales, rieles, eclisas, motores se vendien a precios baratos a los diletantes de "TECNIC".

Concejos importantes.

Nuestra Firma "UNICA" soc. Departamento "TECNIC" en Courtrai-Bélgica tendra el gusto de informar por escrito à los diletantes de Tecnic, deseando consultarnos y eventualmente exponernos sus deseos. En caso de reclamación justificada, una contestación muy favorable puede darse por nuestros técnicos y entera satisfacción quedará siempre concedida.

PRECIOS IMPUESTOS DE VENTA.

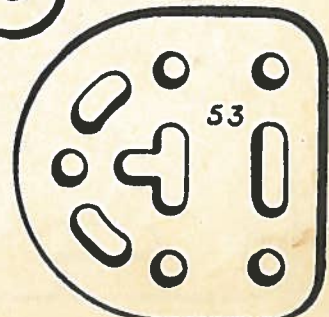
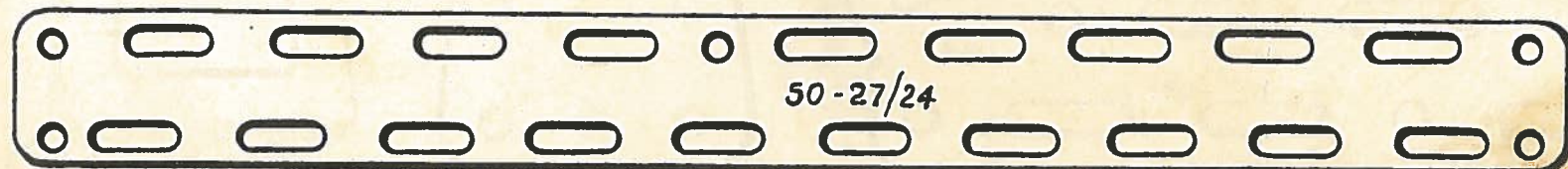
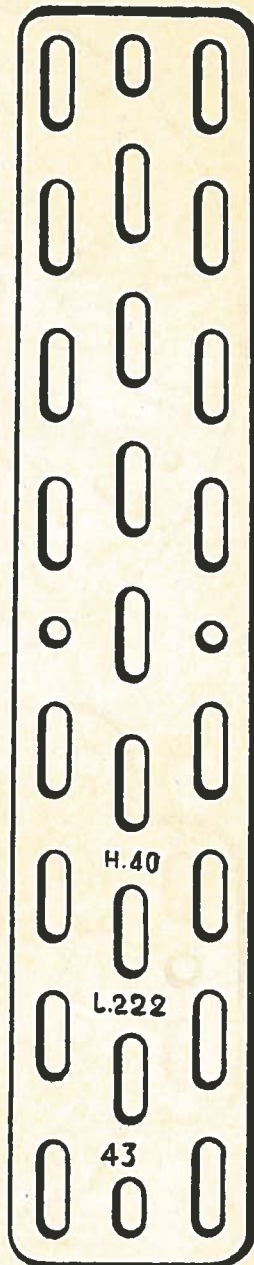
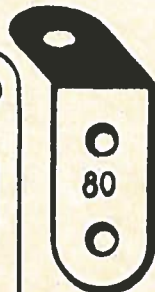
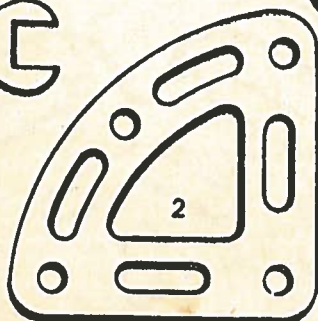
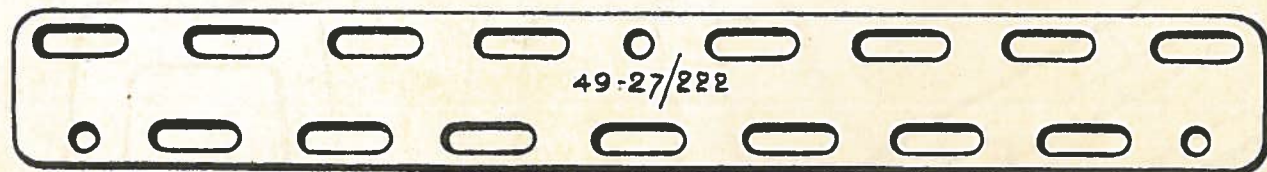
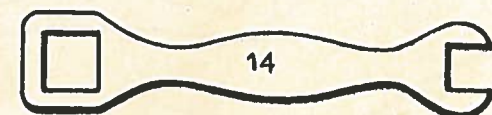
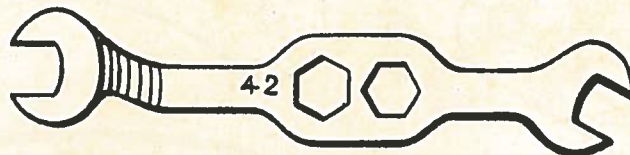
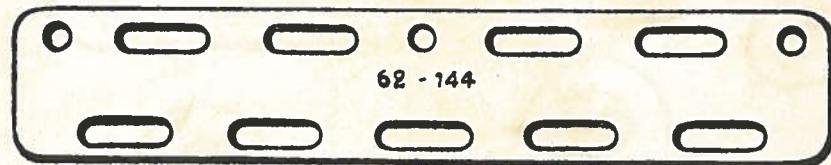
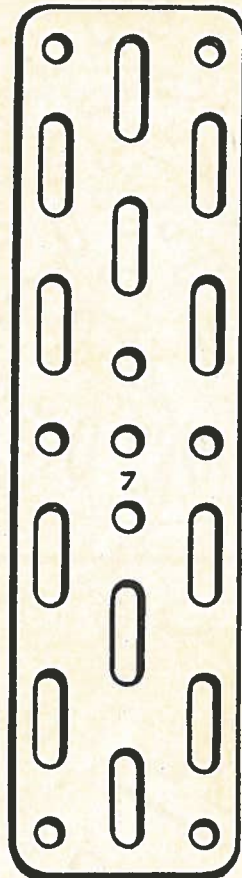
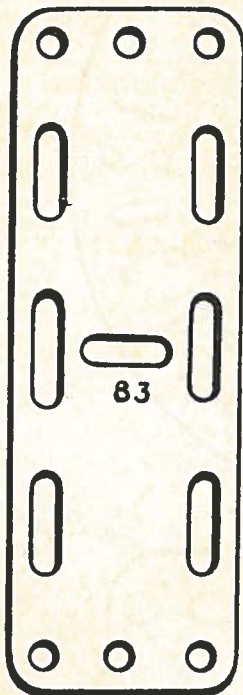
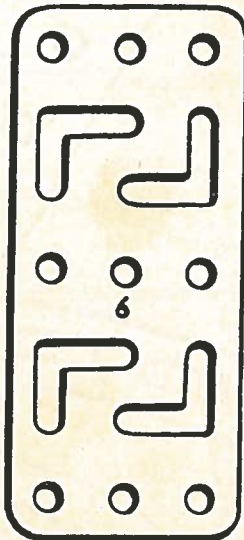
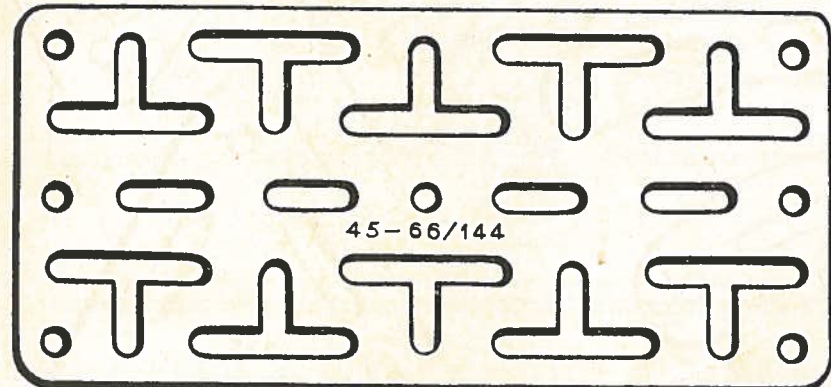
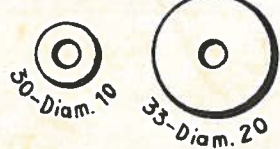

PIÈCES
STUKKEN



PIECES
PIEZAS

PIÈCES
STUKKEN

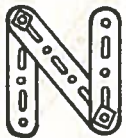
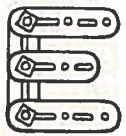

PIECES
PIEZAS

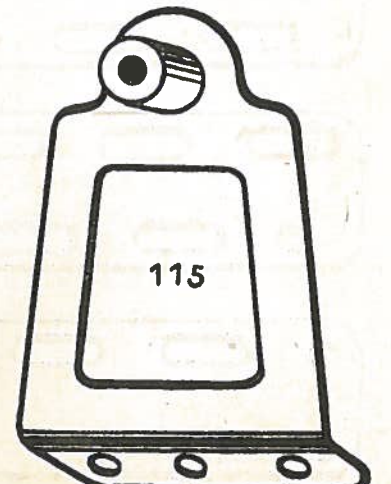
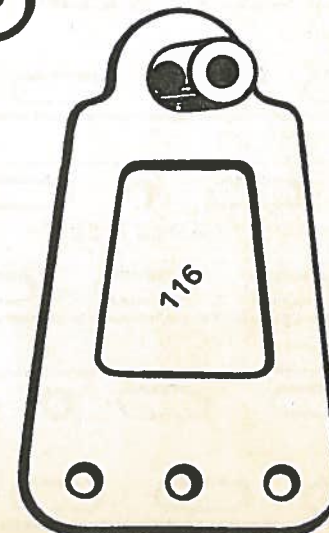
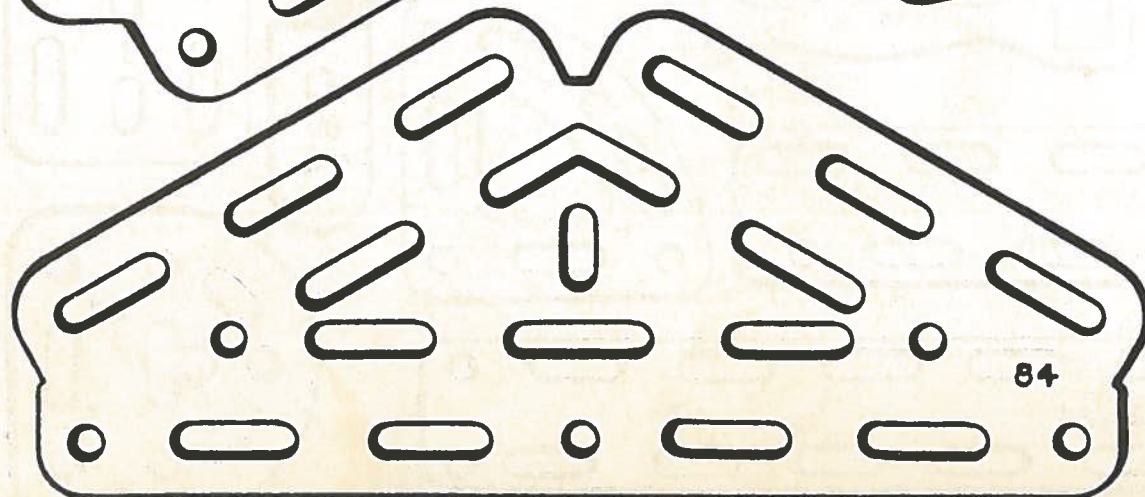
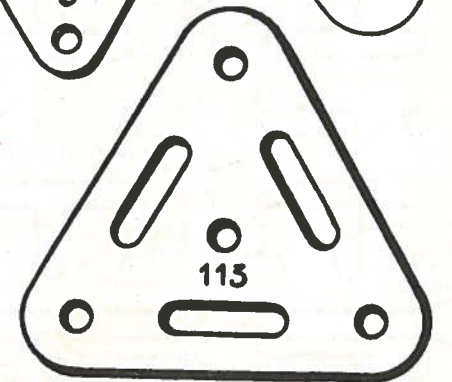
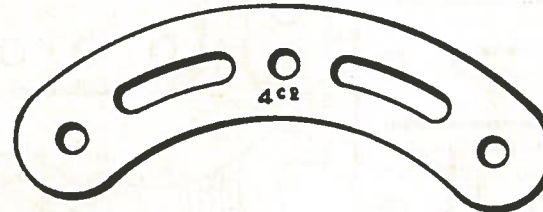
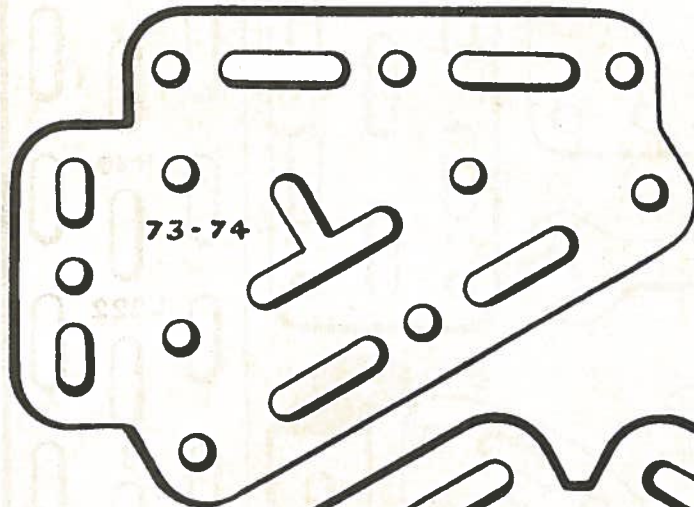
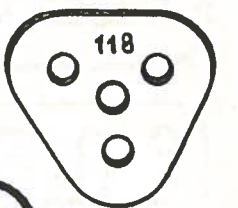
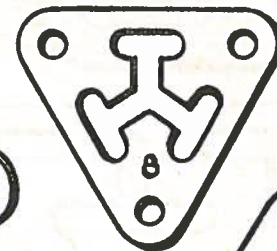
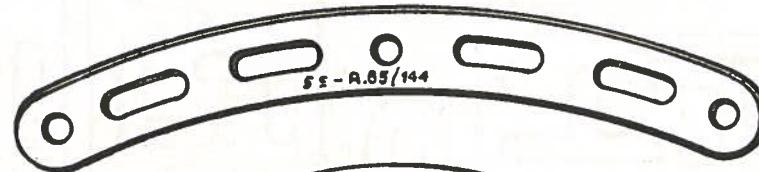
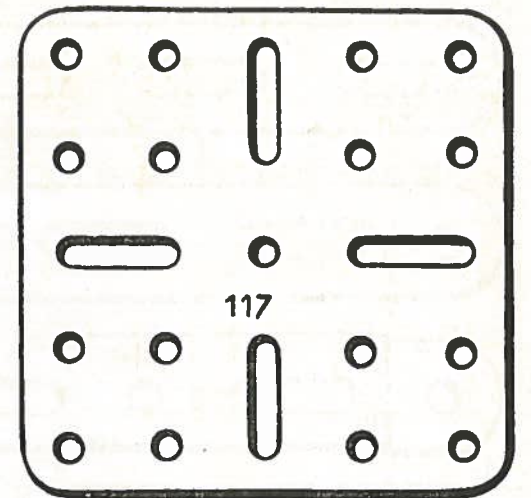
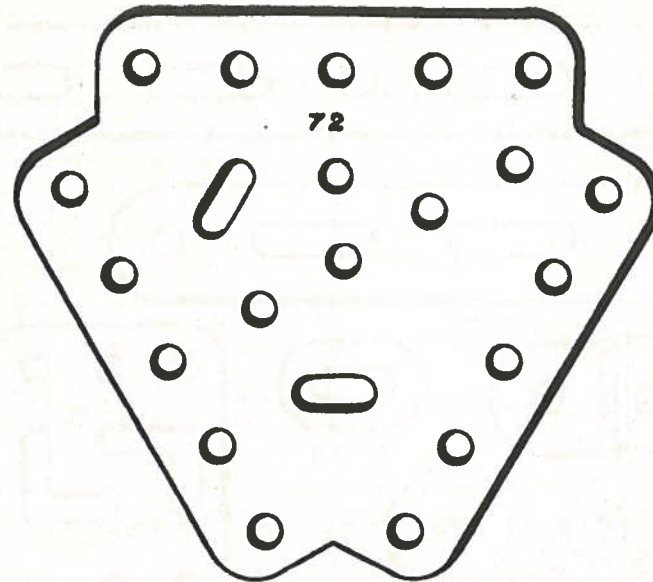
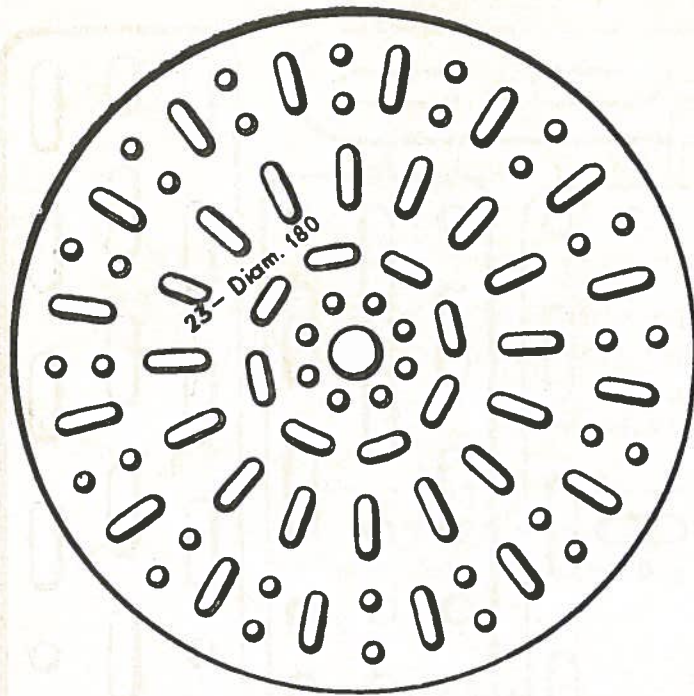

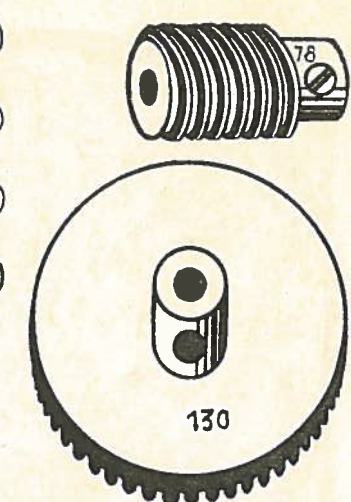
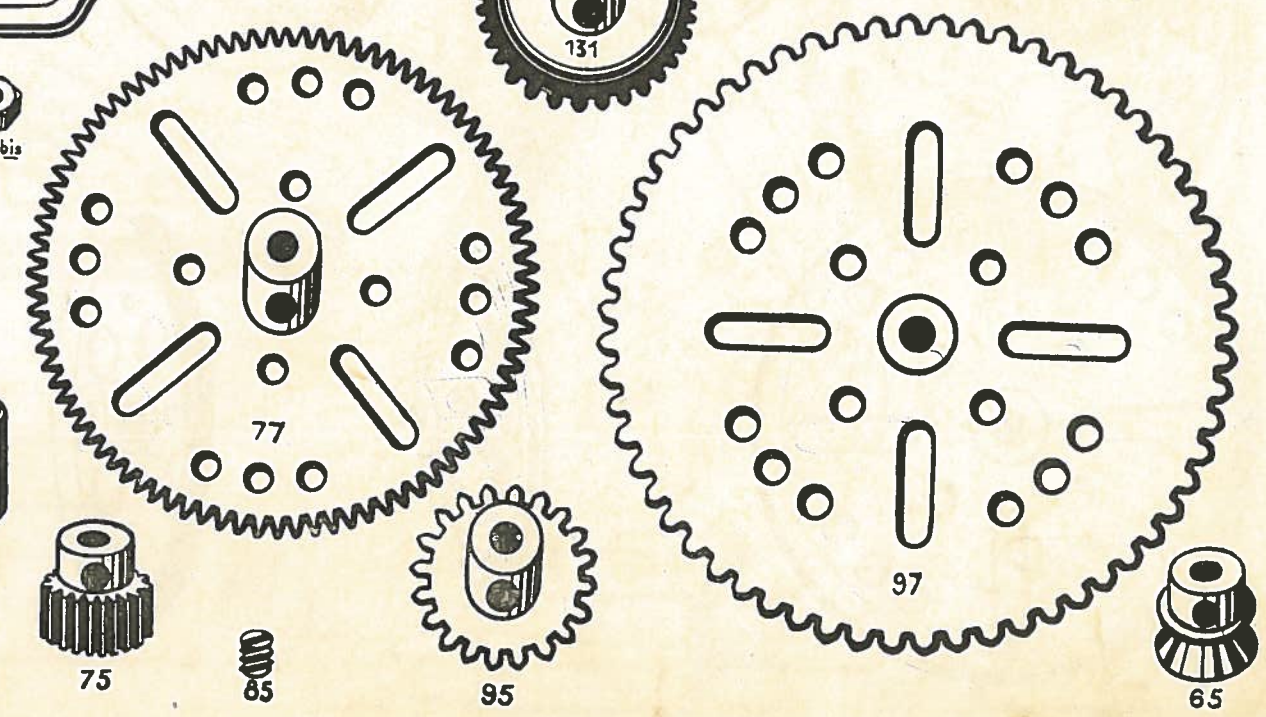
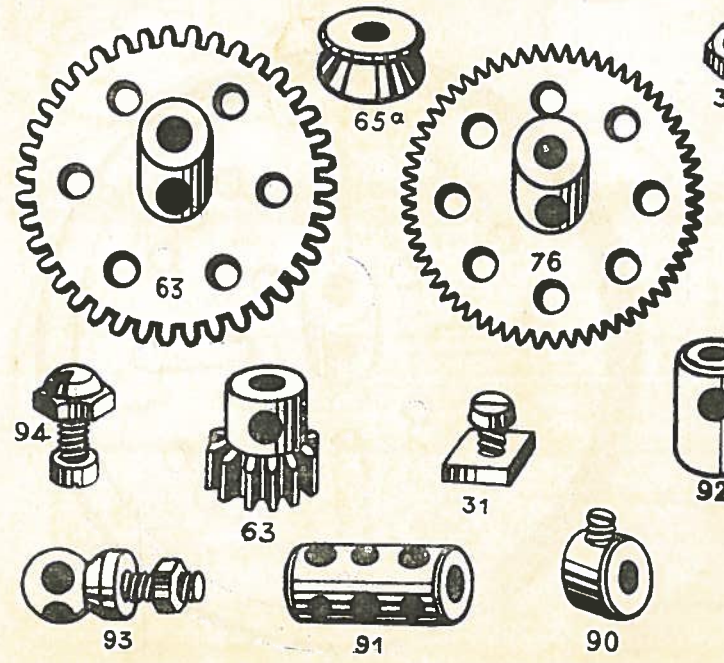
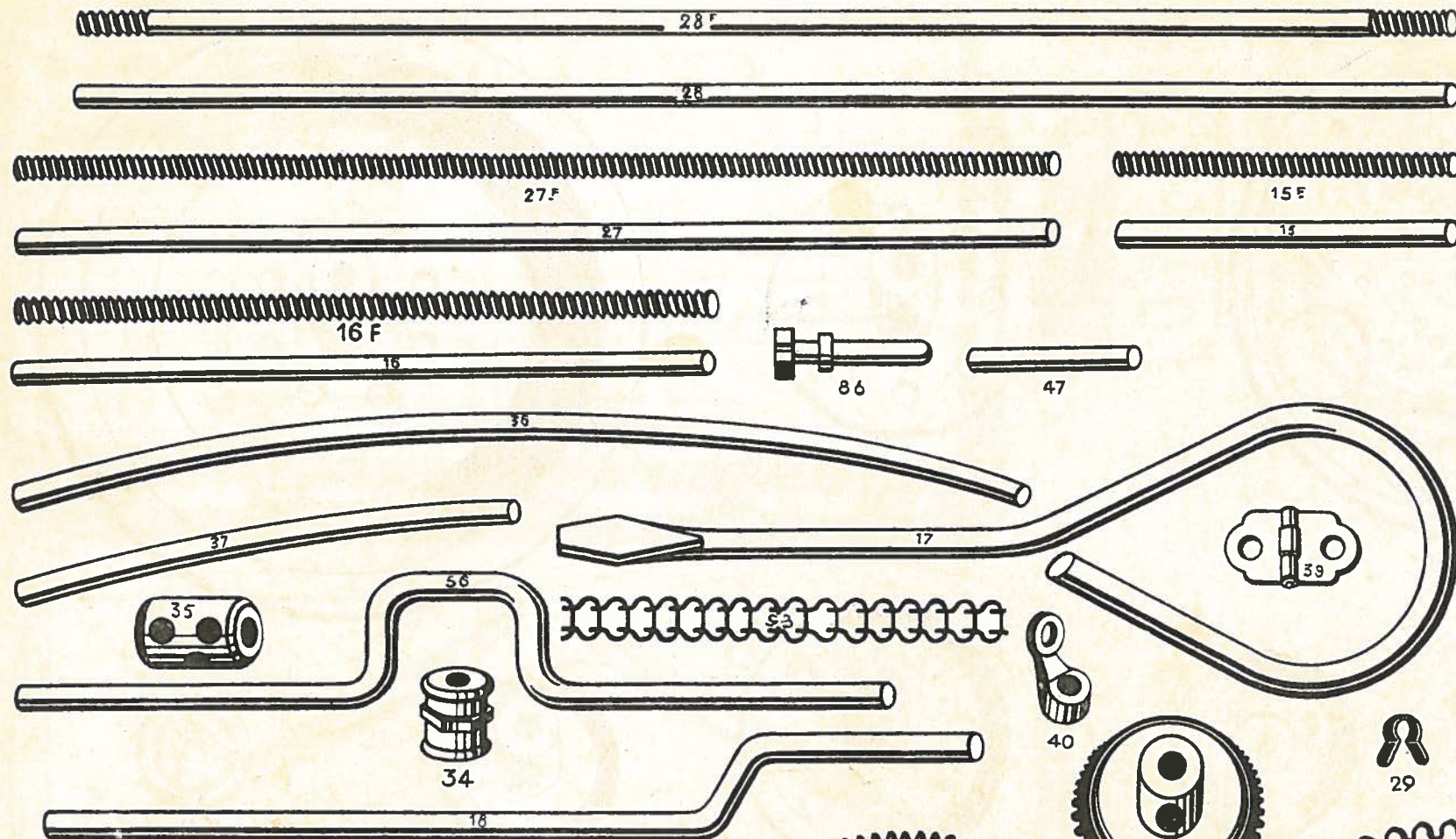

PIÈCES
STUKKEN

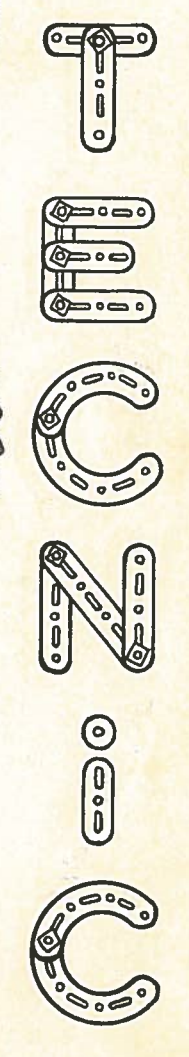

PIECES
PIEZAS

PIÈCES
STUKKEN

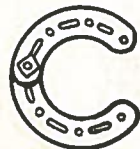
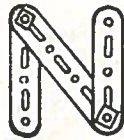
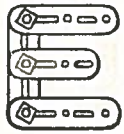

PIECES
PIEZAS

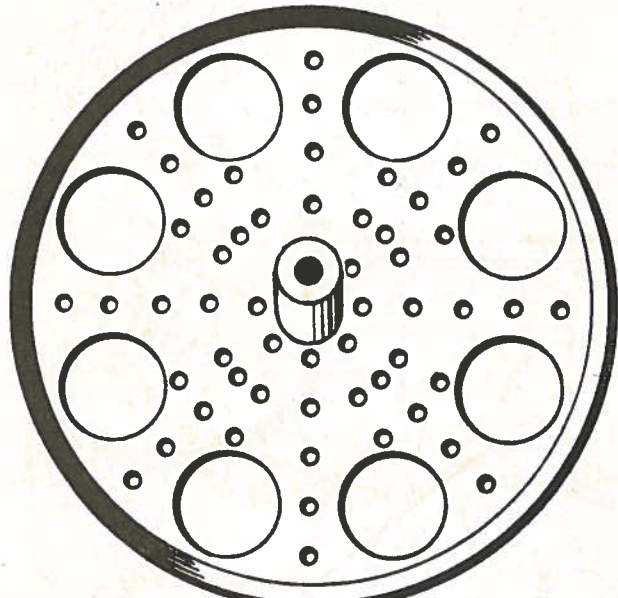

71 - Diam. 156

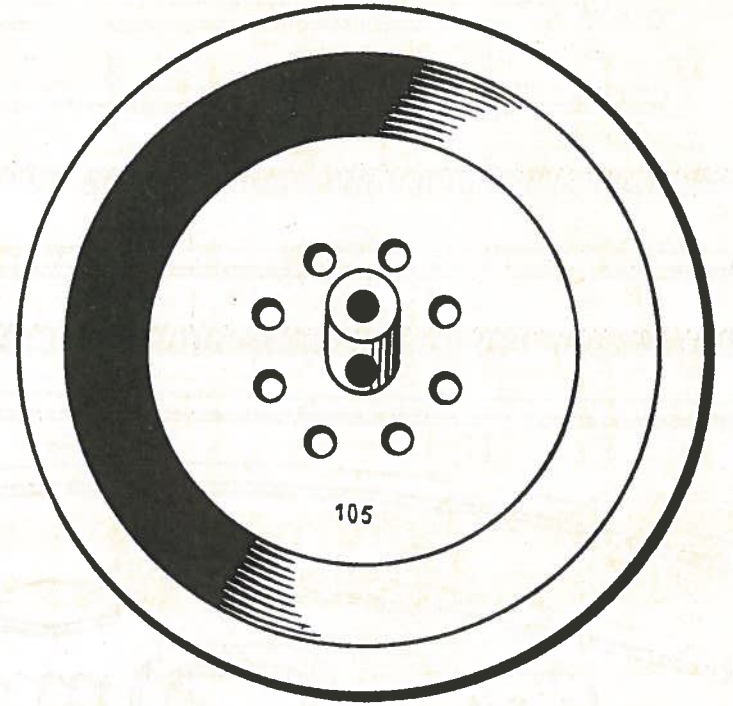
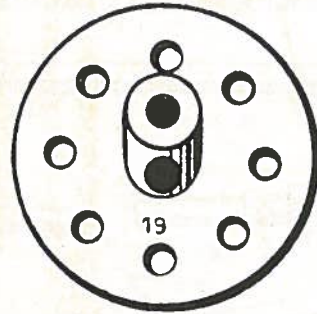

32



66^a

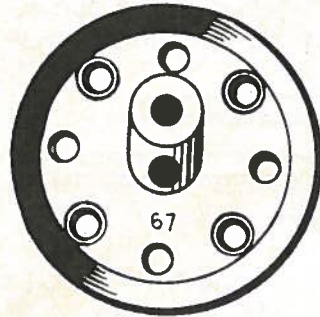

67



66



120

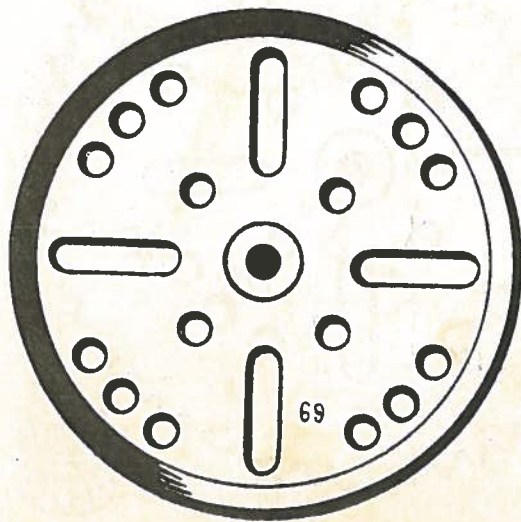

69



20



68

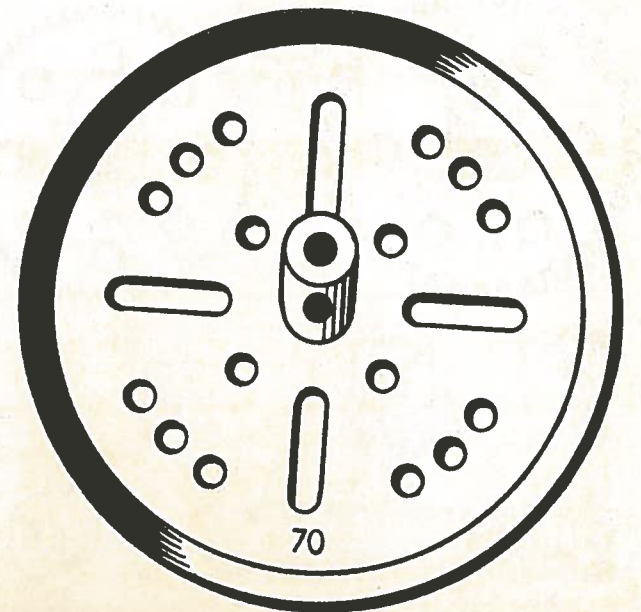

70

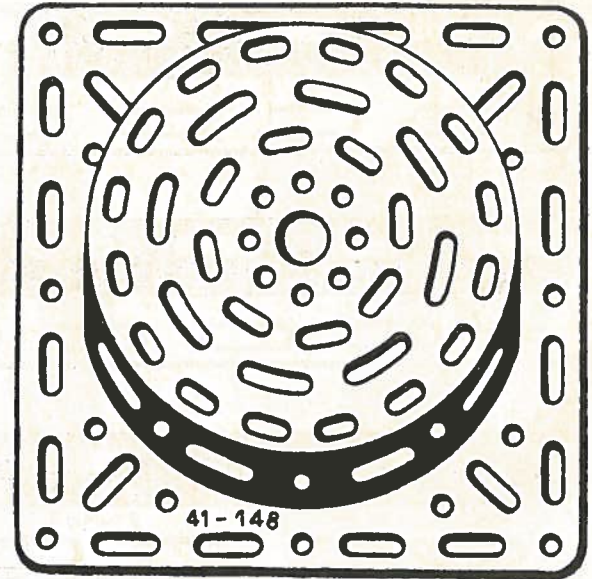
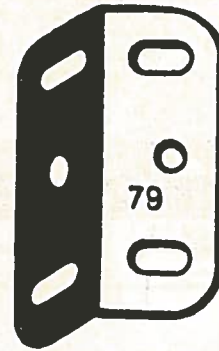
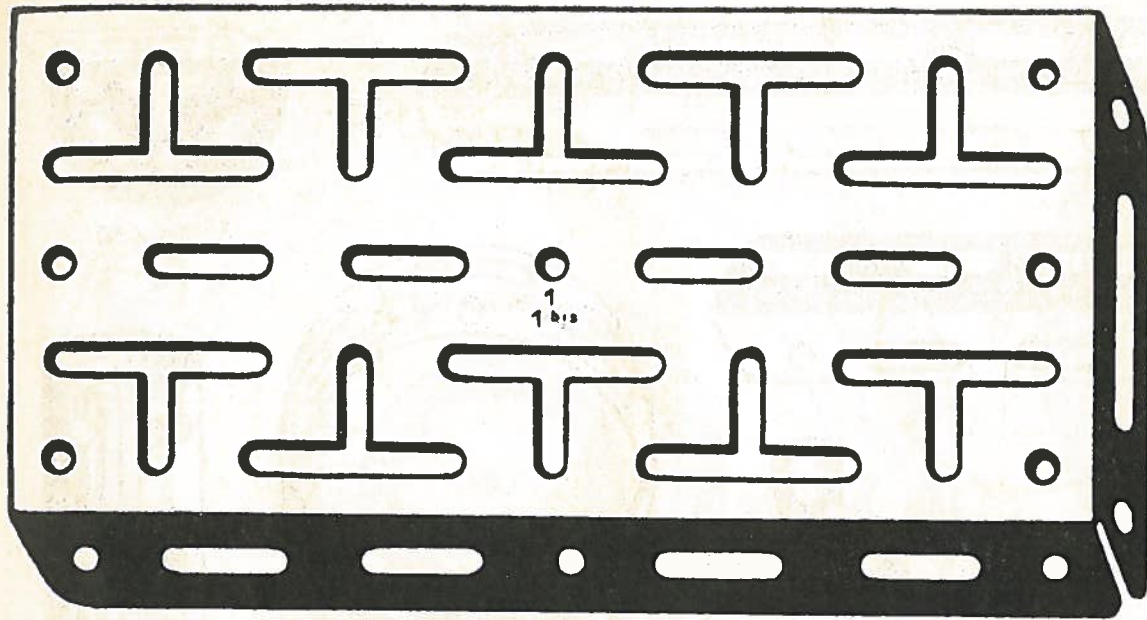

PIÈCES
STUKKEN

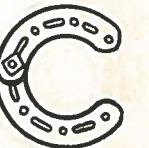
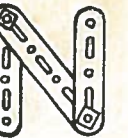
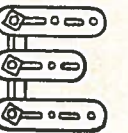
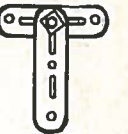

PIECES
PIEZAS

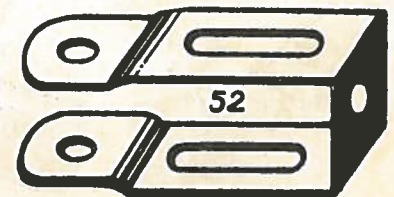
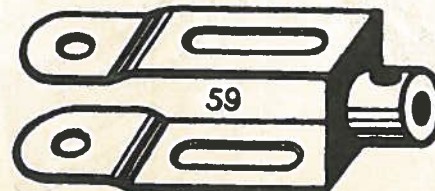
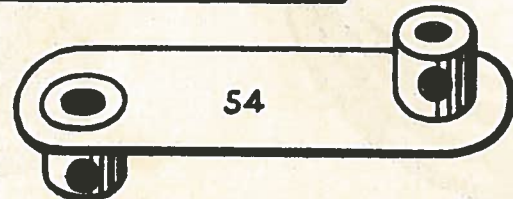
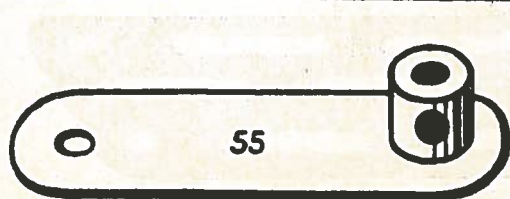
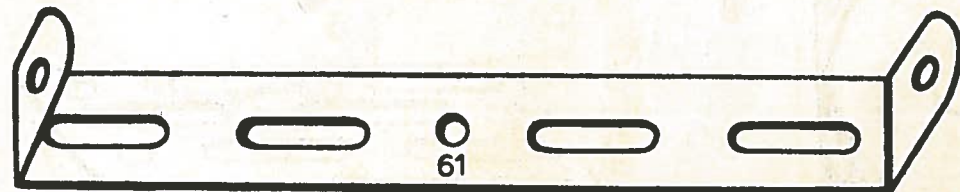
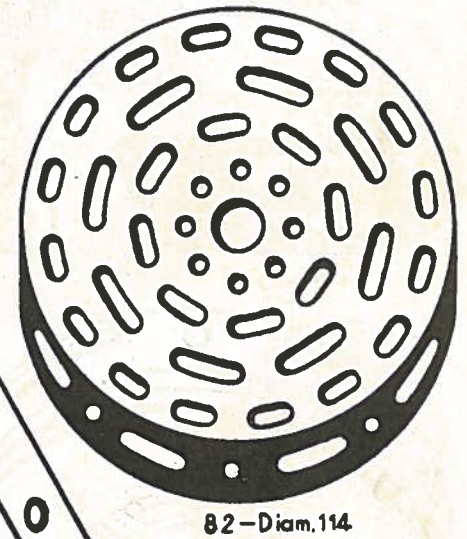
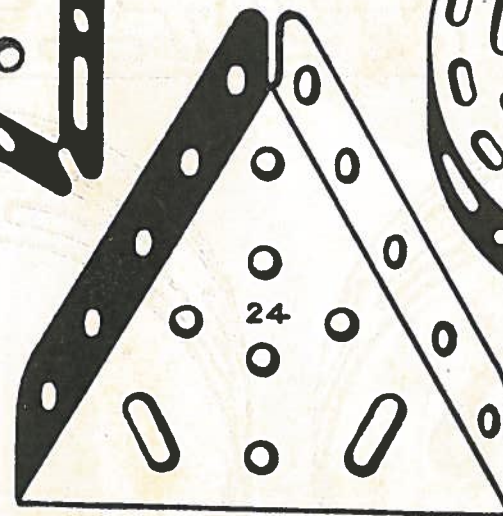
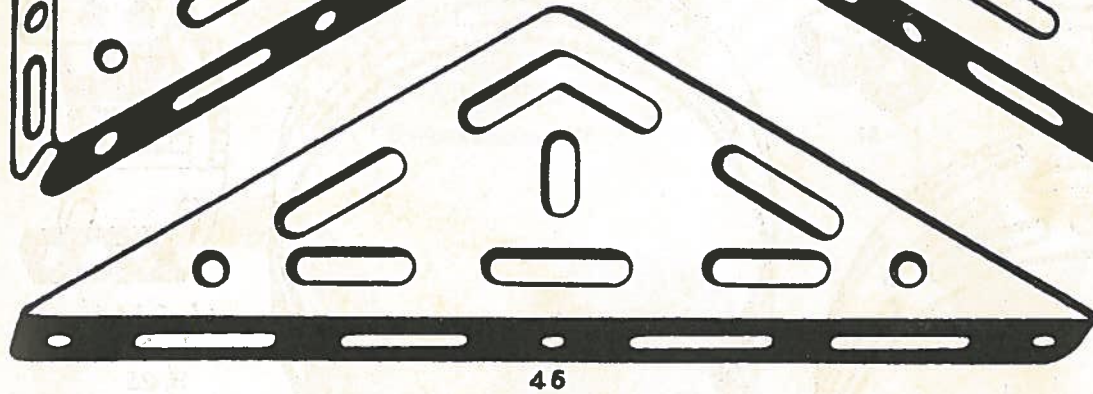
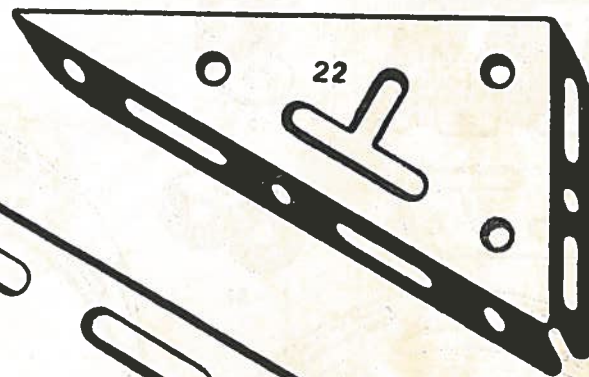
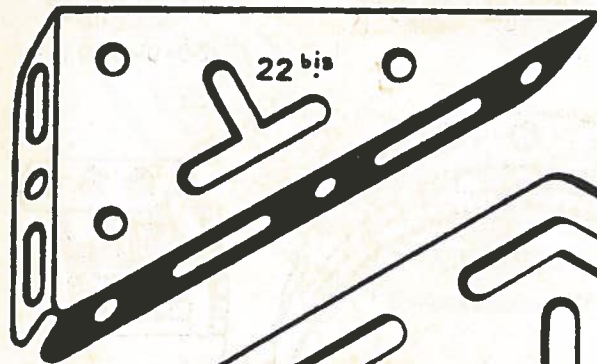

PIÈCES

STUKKEN

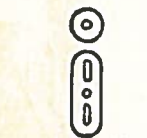
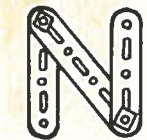
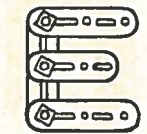

PIECES

PIEZAS

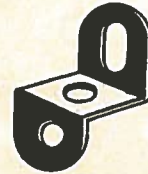
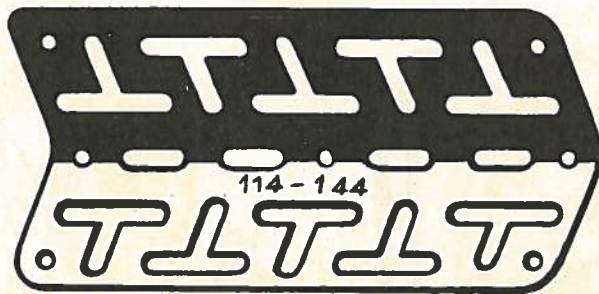
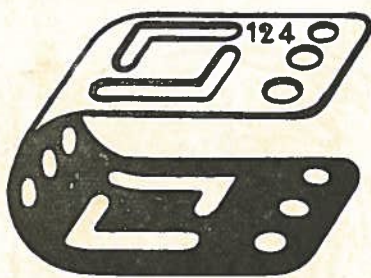
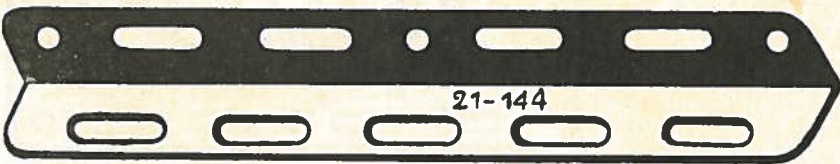
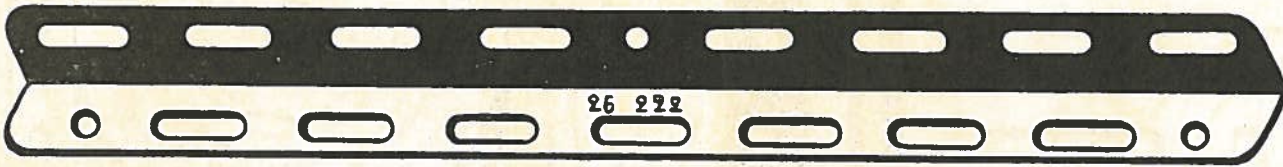
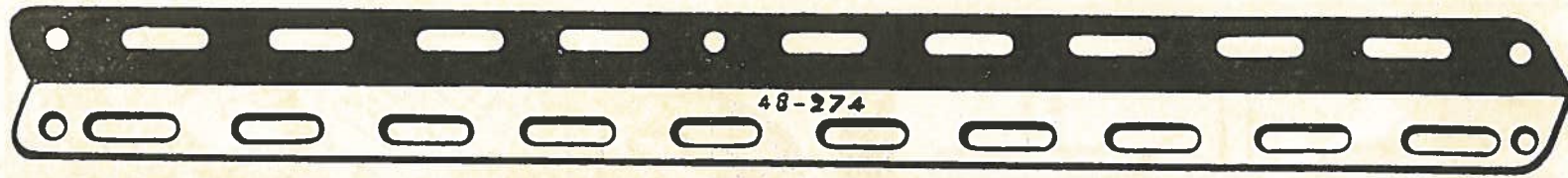

9-20/30

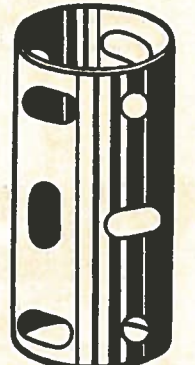

58-Diam.29 L.52

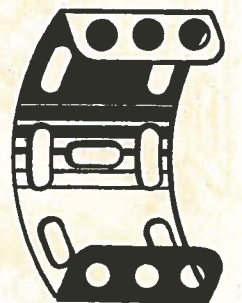
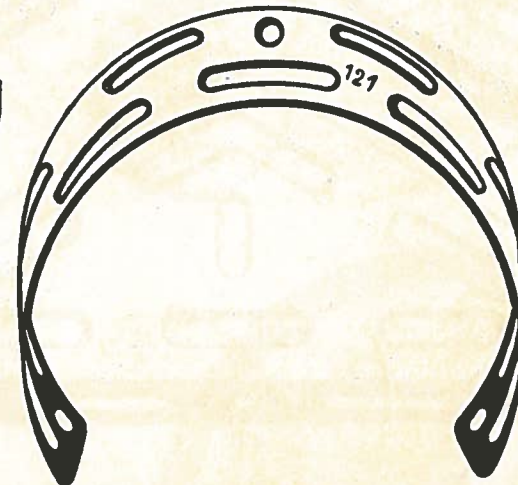

44-R.34,5
L.66
H.25

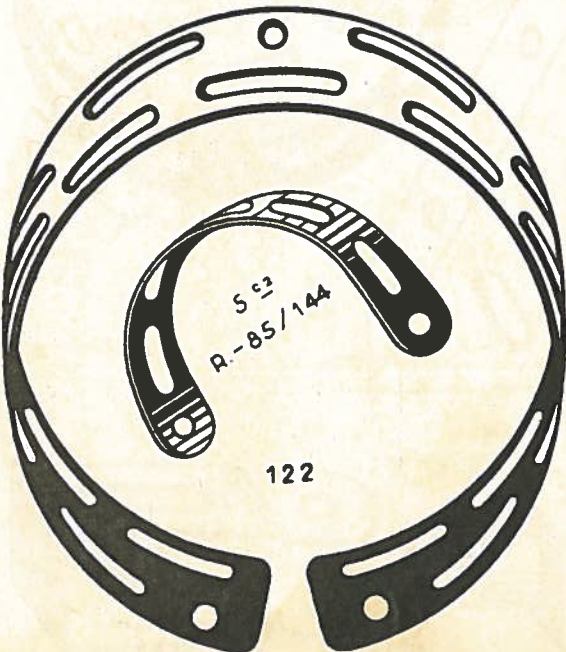

122



64

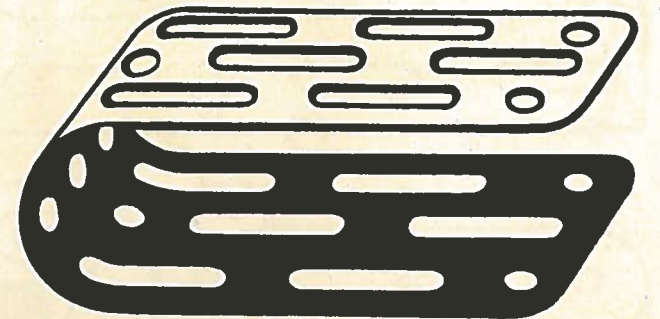

125

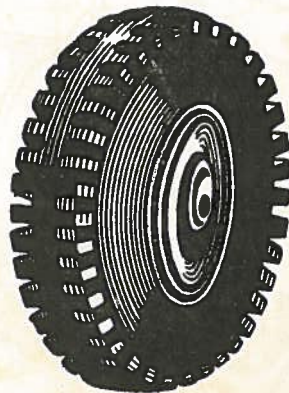
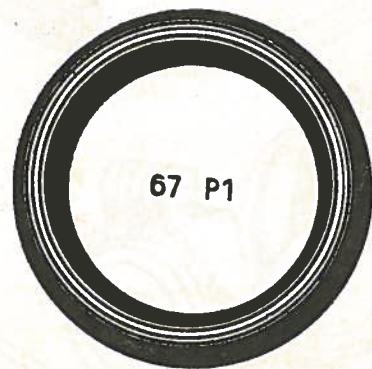
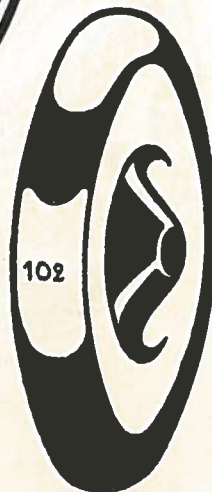
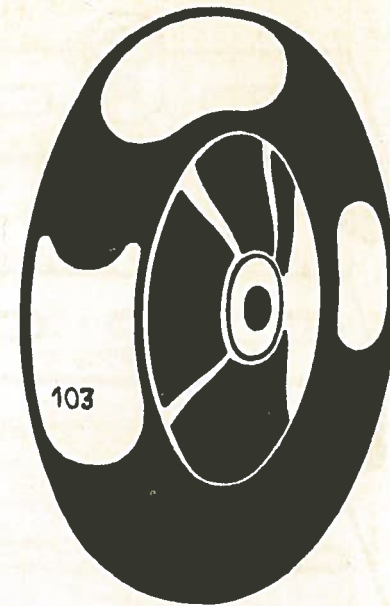
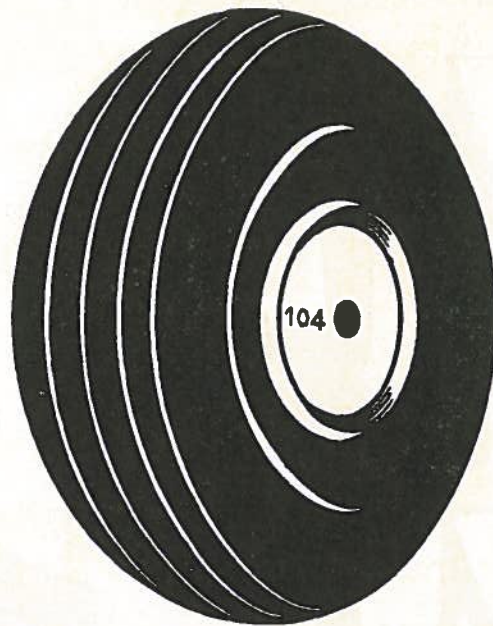
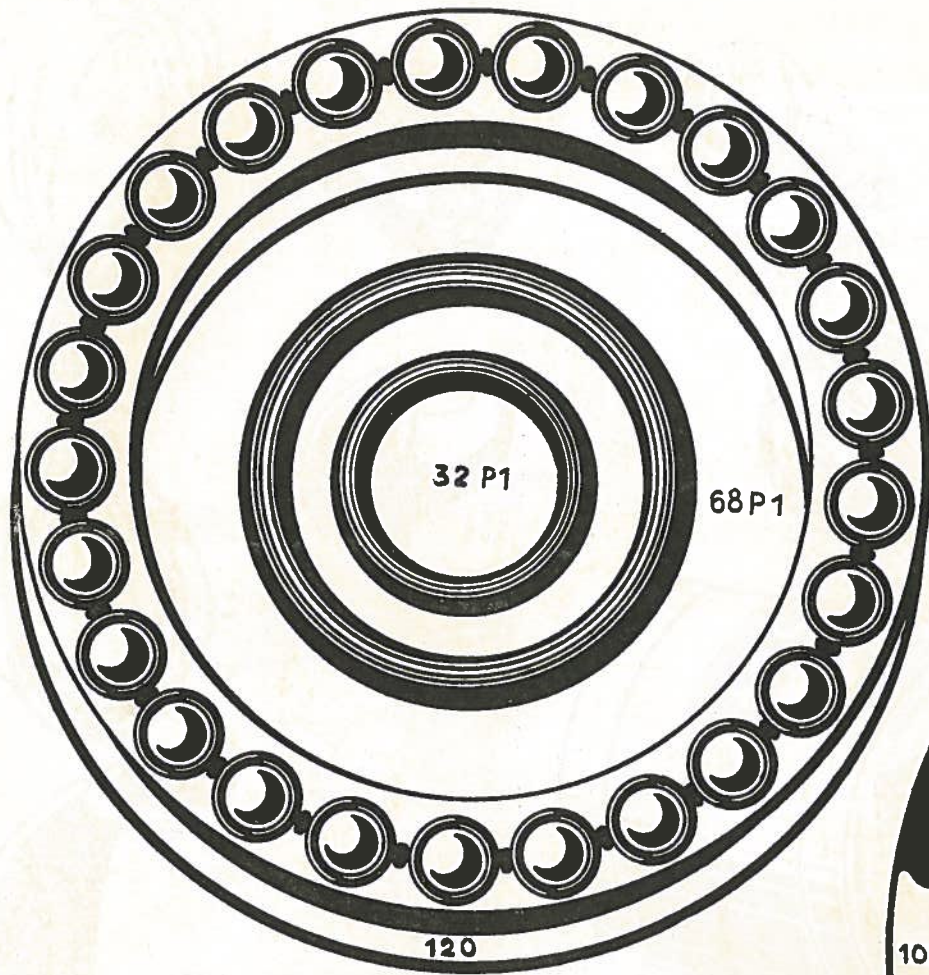

PIÈCES
STUKKEN

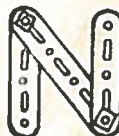
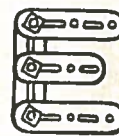

PIECES
PIEZAS

Apr 100-2-80

PIÈCES
STUKKEN

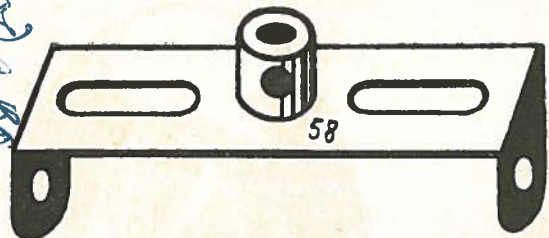

58

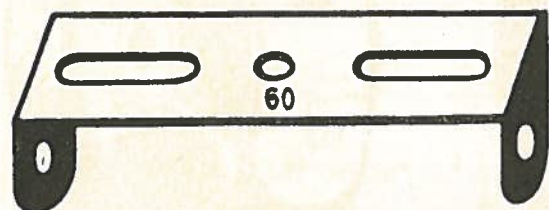

60

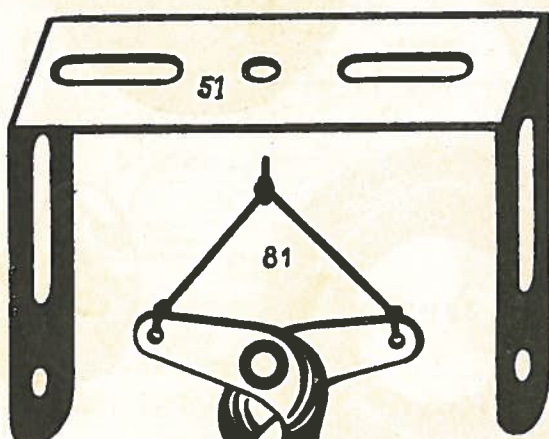

51

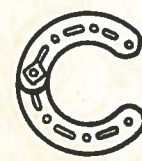
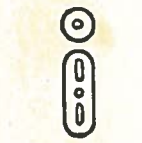
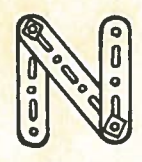
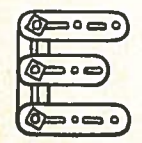
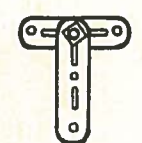

PIECES
PIEZAS

157

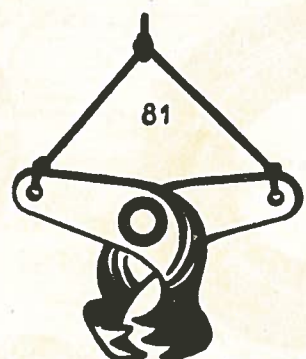

81



108



111 - Lamp 6 Volt
112 - " 8 Volt

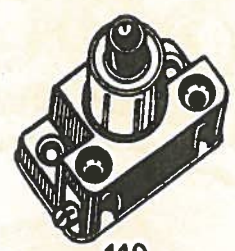

110



109



106

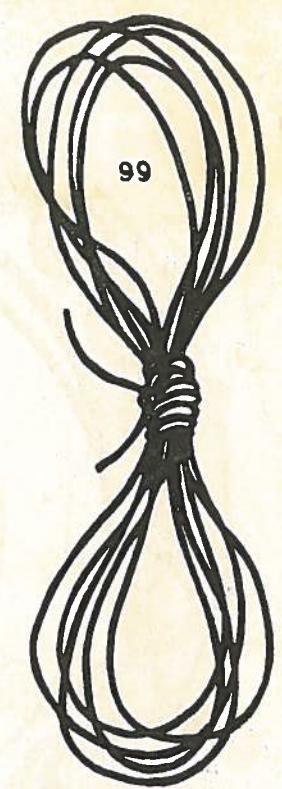

99

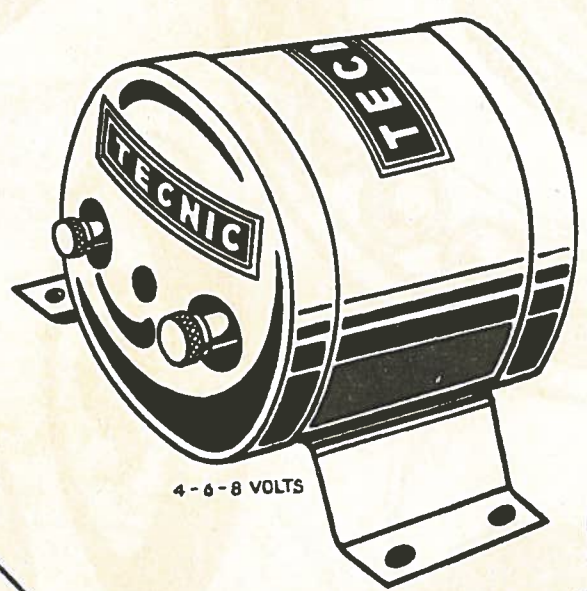

4-6-8 VOLTS

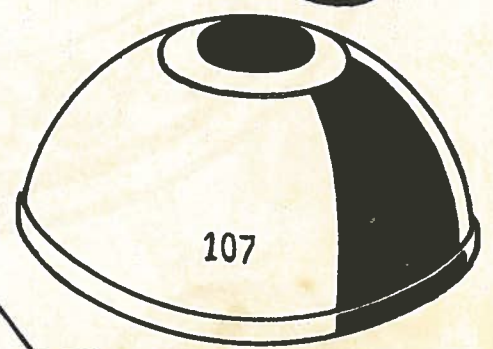

107

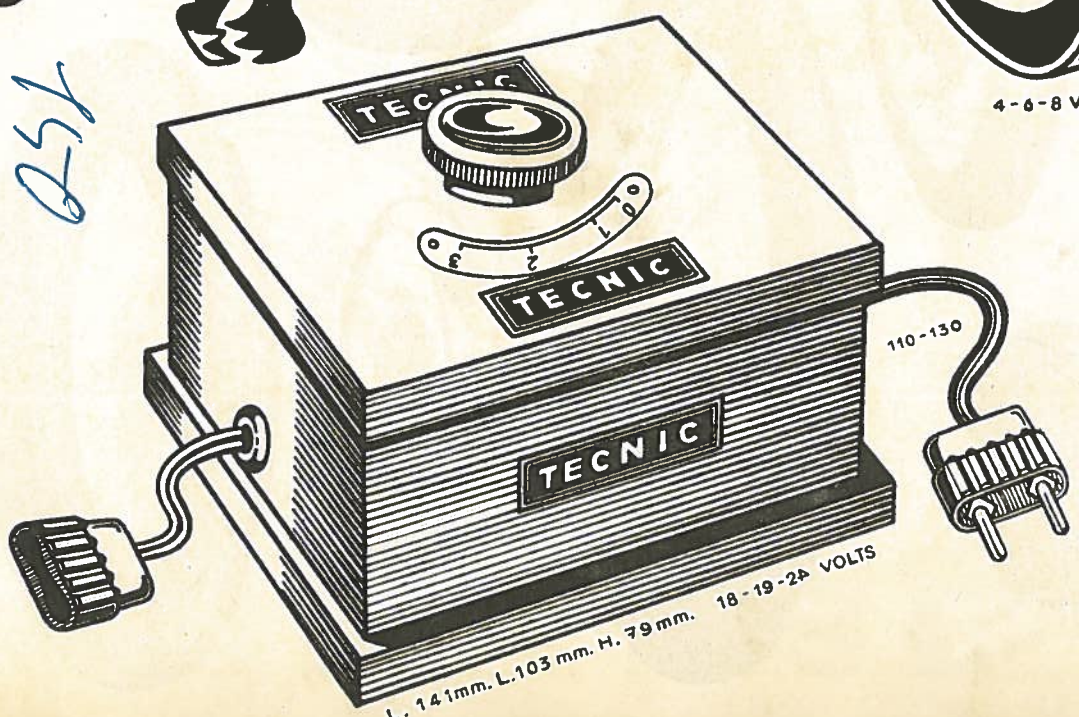

L. 141mm. L.103 mm. H. 79mm. 18-19-24 VOLTS

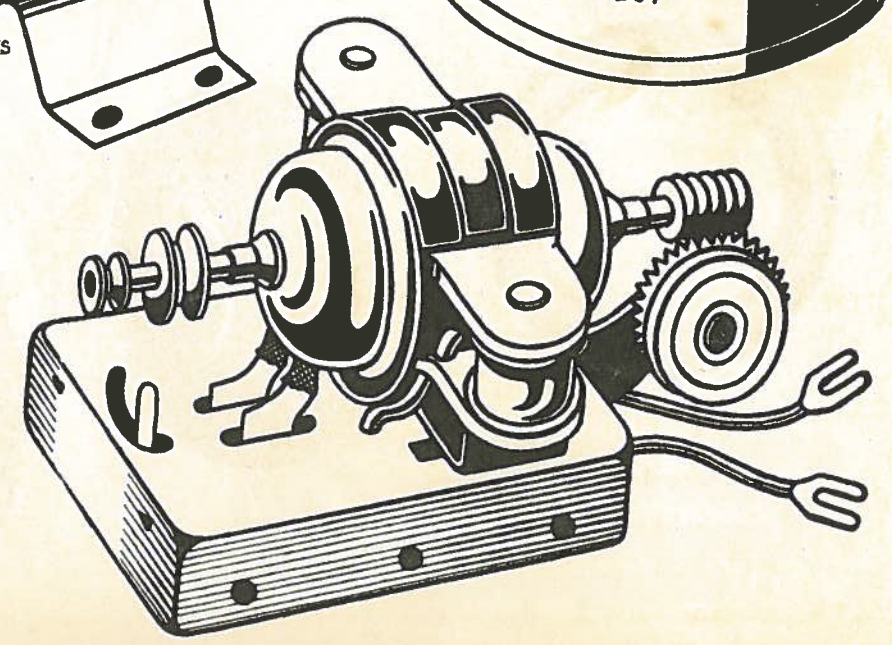

1. Balance - Weegschaal
Balance - Balanza

Pièces employées
 Gebruikte stukken

1	.	.	N° 1
2	.	.	3
1	.	.	4
2	.	.	9
1	.	.	10
1	.	.	12
2	.	.	19
9	.	.	31

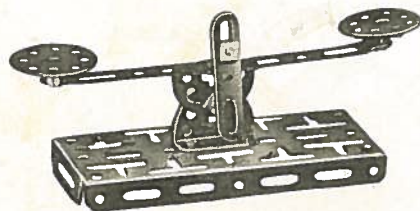

1

2. Charette (1 bras) - Stootkar
Hand-Cart - Carreta

Pièces employées
 Gebruikte stukken

1	.	.	N° 1
1	.	.	3
3	.	.	4
1	.	.	8
2	.	.	9
1	.	.	12
1	.	.	16
2	.	.	19
11	.	.	31

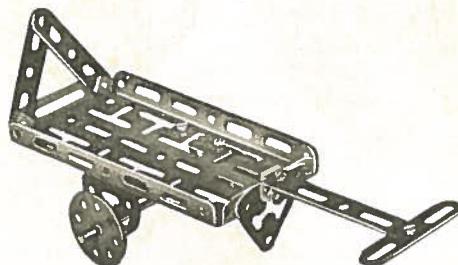

2

3. Chariot à Lin - Vlaswagen
Flax-Waggon
Carre'on para transportar lino

Pièces employées
 Gebruikte stukken

1	.	.	N° 1
1	.	.	3
3	.	.	4
1	.	.	8
2	.	.	9
1	.	.	12
1	.	.	16
2	.	.	19
11	.	.	31

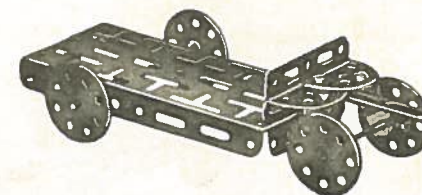

3

4. Carroussel - Draaimolen
Tilting
Caballitos ("Carousel")

Pièces employées
 Gebruikte stukken

1	.	.	N° 1
2	.	.	3
4	.	.	4
2	.	.	8
2	.	.	9
2	.	.	12
2	.	.	16
3	.	.	19
2	.	.	29
15	.	.	31

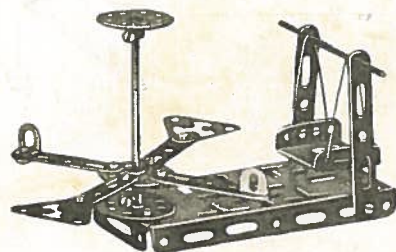

4

5. Tracteur - Tractor

Pièces employées
 Gebruikte stukken

1	.	.	N° 1
2	.	.	3
4	.	.	4
2	.	.	8
2	.	.	9
2	.	.	12
2	.	.	13
2	.	.	16
4	.	.	19
22	.	.	31

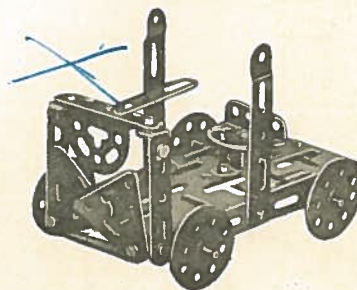

5

6. Attelage - Gespan
Team - Yunta

Pièces employées
 Gebruikte stukken

1	.	.	N° 1
4	.	.	4
2	.	.	8
2	.	.	9
1	.	.	10
2	.	.	11
1	.	.	12
2	.	.	16
4	.	.	19
2	.	.	30
13	.	.	31
2	.	.	33



6

**7 Chariot - platte wagen
(4 roues)
Flat-Waggon · Carre'on**

Pièces employées
Gebruikte stukken

1	.	N° 1
1	.	3
2	.	11
2	.	12
2	.	16
4	.	19
2	.	29
7	.	31

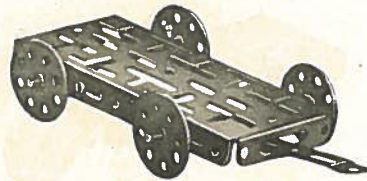

7

**9. Brouette - Kruiwagen
Barrow - Carretila**

Pièces employées
Gebruikte stukken

1	.	N° 1
2	.	3
1	.	4
1	.	8
2	.	9
2	.	11
2	.	12
1	.	15
1	.	19
2	.	29
9	.	31

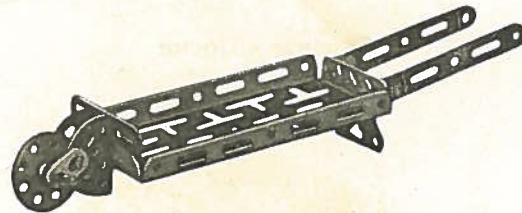

9

**8. Carroussel - Vliegmlen
Tilting
Caballitos (Carrousel)**

Pièces employées
Gebruikte stukken

1	.	N° 1
4	.	4
2	.	8
2	.	9
1	.	16
2	.	19
7	.	31

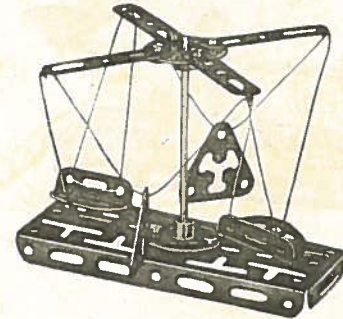

8

**11. Grue - Kraan
Crane - Grua**

Pièces employées
Gebruikte stukken

1	.	N° 1
2	.	3
3	.	4
2	.	8
2	.	9
2	.	12
2	.	16
4	.	19
14	.	31

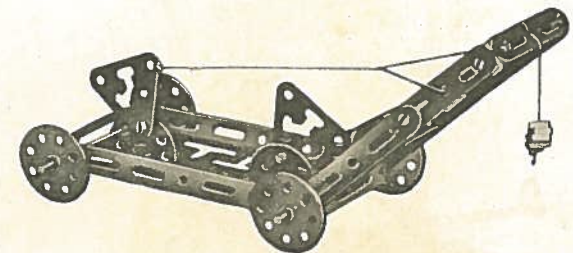

11

**10. Elevateur
Ophaalbak
Lift - Elevador**

Pièces employées
Gebruikte stukken

1	.	N° 1
2	.	3
4	.	4
2	.	8
2	.	9
2	.	11
2	.	16
4	.	19
2	.	29
13	.	31

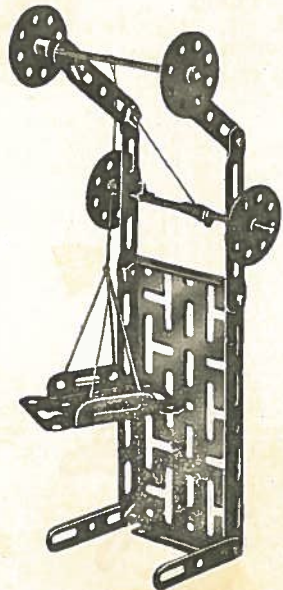

10

12. Grue Mobile - Mobile kraan
Mobil Crane - Grúa movil

Pièces employées
Gebruikte stukken

1	.	.	N° 1
2	.	.	3
3	.	.	4
2	.	.	8
2	.	.	9
1	.	.	12
2	.	.	16
4	.	.	19
15	.	.	31

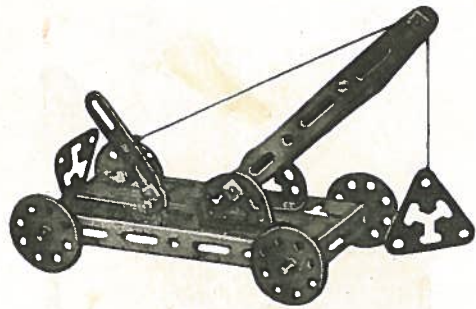

12

15. Locomotive - Locomotief
Locomotive - Locomotora

Pièces employées
Gebruikte stukken

1	.	.	N° 1
1	.	.	3
2	.	.	8
1	.	.	9
2	.	.	12
2	.	.	16
4	.	.	19
12	.	.	31

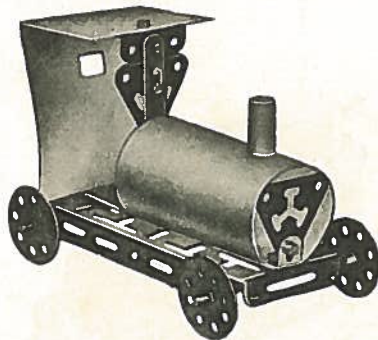

15

14. Chariot - Driewielkar
(3 roues)
Three-Wheelcar
Carret'on (3 ruedas)

Pièces employées
Gebruikte stukken

1	.	.	N° 1
1	.	.	4
2	.	.	8
2	.	.	9
2	.	.	11
2	.	.	12
2	.	.	13
1	.	.	15
1	.	.	16
3	.	.	19
2	.	.	29
14	.	.	31

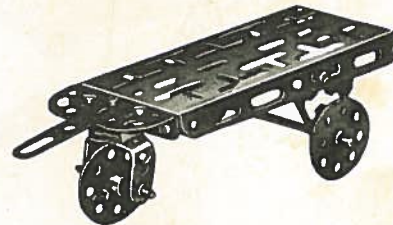

14

13. Char à voile - Zeilwagen
Sail-Car - Carret'on de vela

Pièces employées
Gebruikte stukken

1	.	.	N° 1
1	.	.	3
3	.	.	4
1	.	.	8
2	.	.	9
2	.	.	11
1	.	.	12
2	.	.	16
4	.	.	19
14	.	.	31

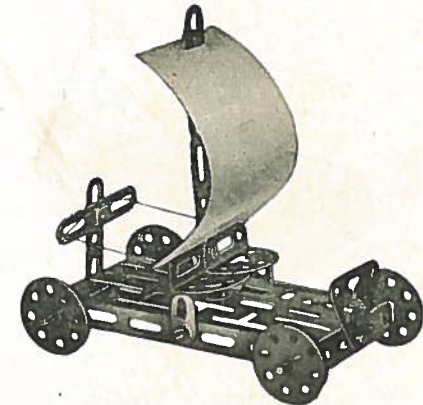

13

16. Aspirateur - Luchttrekker
Aspirator - Aspirador

Pièces employées
Gebruikte stukken

1	.	.	N° 1
4	.	.	4
2	.	.	8
2	.	.	9
2	.	.	11
1	.	.	16
1	.	.	19
2	.	.	30
12	.	.	31

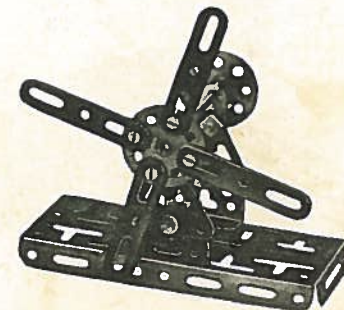

16

17. **JEEP**

Pièces employées
 Gebruikte stukken

1	.	.	N° 1
1	.	.	3
8	.	.	4
2	.	.	6
2	.	.	8
2	.	.	9
2	.	.	10
3	.	.	11
3	.	.	12
2	.	.	13
2	.	.	16
4	.	.	19
3	.	.	30
34	.	.	31
4	.	.	33

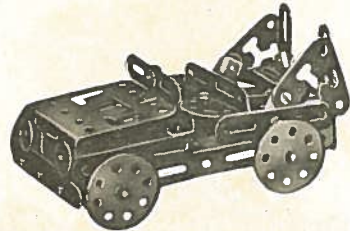

17

20. **Tracteur - Tractor**

Pièces employées
 Gebruikte stukken

1	.	.	N° 1
1	.	.	3
8	.	.	4
2	.	.	6
2	.	.	8
2	.	.	9
3	.	.	11
4	.	.	12
1	.	.	13
2	.	.	16
4	.	.	19
4	.	.	30
30	.	.	31
2	.	.	32
4	.	.	33

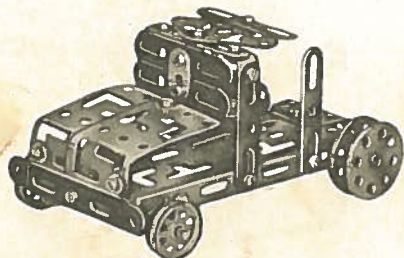

20

19. **Bateau - Schip
 Ship - Buque**

Pièces employées
 Gebruikte stukken

1	.	.	N° 1
8	.	.	4
2	.	.	5
2	.	.	6
2	.	.	8
1	.	.	9
1	.	.	10
3	.	.	11
4	.	.	12
2	.	.	13
2	.	.	16
2	.	.	19
32	.	.	31
1	.	.	32

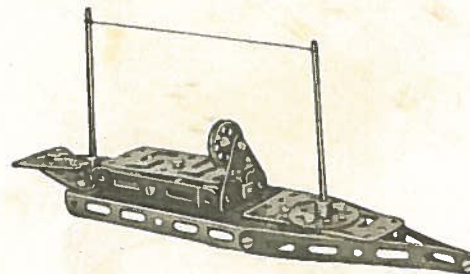

19

18. **Grue Mobile - Mobiele kraan
 Mobil Crane - Grúa móvil**

Pièces employées - Gebruikte stukken

1	.	.	N° 1
2	.	.	3
4	.	.	4
2	.	.	5
2	.	.	6
2	.	.	8
2	.	.	9
4	.	.	11
3	.	.	12
2	.	.	16
1	.	.	18
4	.	.	19
2	.	.	29
25	.	.	31
1	.	.	30

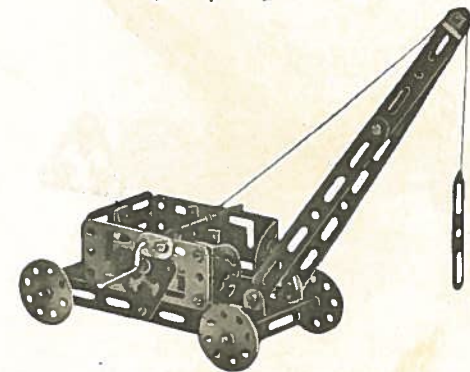

18

21. **Yacht - Jacht - Yacht - Yate**

Pièces employées
 Gebruikte stukken

1	.	.	N° 1
8	.	.	4
2	.	.	5
2	.	.	6
1	.	.	8
2	.	.	9
2	.	.	11
4	.	.	12
2	.	.	13
1	.	.	16
2	.	.	29
28	.	.	31
1	.	.	32

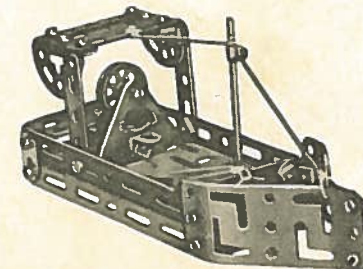

21

22. Grue tournante
Draaiende kraan
Turn-Crane - Grua Giratoria

Pièces employées
Gebruikte stukken

1 . . .	N° 1	2 . . .	N° 16
4 . . .	3	1 . . .	18
5 . . .	4	4 . . .	19
2 . . .	5	2 . . .	29
2 . . .	6	4 . . .	30
2 . . .	8	33 . . .	31
2 . . .	9	2 . . .	32
4 . . .	12	4 . . .	33

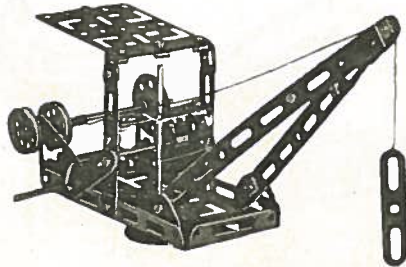

22

25. Grue Mobile - Mobiele kraan
Mobil Crane - Grua móvil

Pièces employées
Gebruikte stukken

1 . . .	N° 1	1 . . .	N° 15
4 . . .	3	2 . . .	16
8 . . .	4	1 . . .	18
2 . . .	5	4 . . .	19
2 . . .	6	2 . . .	29
2 . . .	8	4 . . .	30
2 . . .	9	30 . . .	31
2 . . .	11	2 . . .	32
2 . . .	12	4 . . .	33

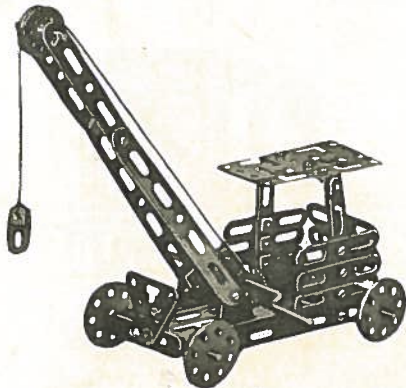

25

24. Camion - Vrachtwagen
Lorry - Camion

Pièces employées
Gebruikte stukken

1 . . .	N° 1	2 . . .	N° 11
4 . . .	3	4 . . .	12
8 . . .	4	2 . . .	16
2 . . .	5	4 . . .	19
2 . . .	6	2 . . .	29
2 . . .	8	4 . . .	30
2 . . .	9	28 . . .	31
2 . . .	10	2 . . .	33

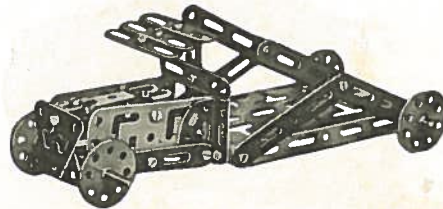

24

23. Diable - Rolwagen
Truck - Diabolo

Pièces employées
Gebruikte stukken

1 . . .	N° 1	3 . . .	N° 11
4 . . .	4	4 . . .	12
2 . . .	5	1 . . .	16
1 . . .	6	1 . . .	19
2 . . .	8	25 . . .	31
1 . . .	9	2 . . .	32

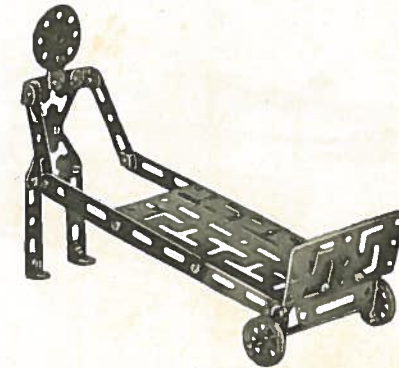

23

26. Attelage - Gespan
Team - Yunta

Pièces employées
Gebruikte stukken

1 . . .	N° 1	2 . . .	N° 10
2 . . .	3	4 . . .	11
7 . . .	4	4 . . .	12
2 . . .	5	2 . . .	16
2 . . .	6	4 . . .	19
1 . . .	8	4 . . .	30
2 . . .	9	29 . . .	31

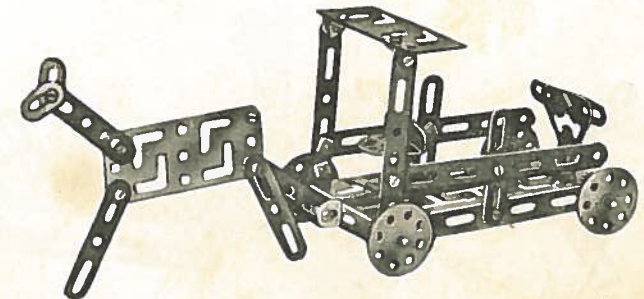

26

**27. Moulin - Draaimolen
Wind-Mill - Molino**

Pièces employées
Gebruikte stukken

1 . . .	N° 1	1 . . .	N° 18
4 . . .	3	2 . . .	19
8 . . .	4	2 . . .	29
2 . . .	8	4 . . .	30
2 . . .	10	28 . . .	31
4 . . .	11	2 . . .	32
4 . . .	12	4 . . .	33
1 . . .	16		

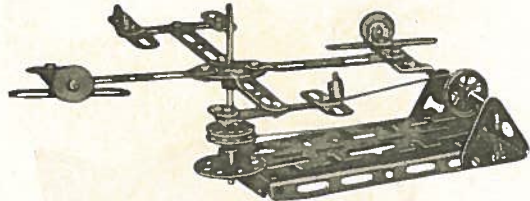

27

**29. Auto de course - Koersauto
Racer - Automóvil de carrera**

Pièces employées
Gebruikte stukken

1 . . .	N° 1	4 . . .	N° 12
2 . . .	3	1 . . .	15
4 . . .	4	2 . . .	16
2 . . .	5	4 . . .	19
2 . . .	6	2 . . .	29
1 . . .	8	30 . . .	31
2 . . .	9	1 . . .	32
2 . . .	10	2 . . .	33
4 . . .	11		

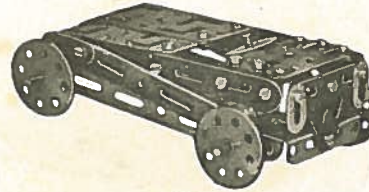

29

**30. Traineau attelé
Paard met slede
Sleigh - Rastra de yunta**

Pièces employées
Gebruikte stukken

1 . . .	N° 1	1 . . .	N° 6
1 . . .	3	3 . . .	10
7 . . .	4	1 . . .	12
2 . . .	5	15 . . .	31

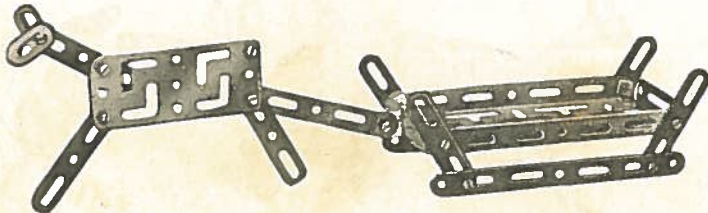

30

**28. Avion - Vliegtuig
Airplane - Aeroplano**

Pièces employées
Gebruikte stukken

4 . . .	N° 3	3 . . .	N° 13
5 . . .	4	2 . . .	15
2 . . .	5	1 . . .	16
2 . . .	6	2 . . .	30
1 . . .	8	27 . . .	31
2 . . .	9	2 . . .	32
4 . . .	11	1 . . .	33
3 . . .	12		

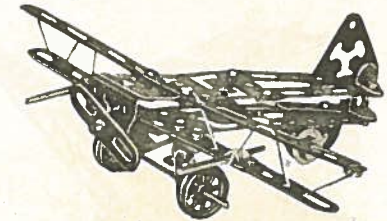

28

**31. Ascenseur - Ophaalbak
Lift - Ascensor**

Pièces employées
Gebruikte stukken

1 . . .	N° 1	1 . . .	N° 16
6 . . .	4	1 . . .	18
2 . . .	5	1 . . .	19
1 . . .	6	2 . . .	29
2 . . .	11	15 . . .	31
4 . . .	12	3 . . .	33

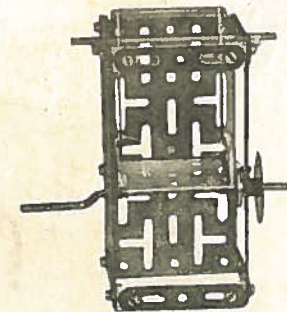

31

32. **Vedette - Snelboot**
Speedboat - Bote

Pièces employées
 Gebruikte stukken

1 . . .	N° 1	2 . . .	N° 11
4 . . .	3	4 . . .	12
5 . . .	4	2 . . .	16
2 . . .	5	4 . . .	19
1 . . .	6	1 . . .	30
2 . . .	8	28 . . .	31
2 . . .	9	1 . . .	32

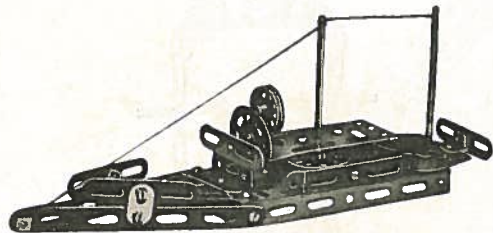

32

34. **Vedette - Wachtschip**
Spy-boat - Bote

Pièces employées
 Gebruikte stukken

1 . . .	N° 1	1 . . .	N° 9
2 . . .	3	3 . . .	12
3 . . .	4	2 . . .	16
2 . . .	5	2 . . .	19
2 . . .	6	22 . . .	31
2 . . .	8	1 . . .	31

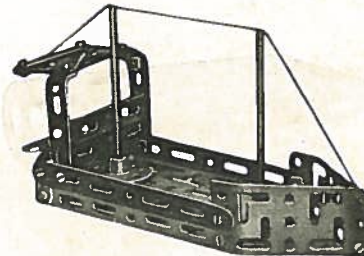

34

33. **Balance - Weegschaal**
Balance - Balanza

Pièces employées
 Gebruikte stukken

1 . . .	N° 1	1 . . .	N° 11
7 . . .	4	4 . . .	12
2 . . .	5	1 . . .	15
2 . . .	6	2 . . .	19
2 . . .	7	4 . . .	30
2 . . .	8	25 . . .	31
2 . . .	9		

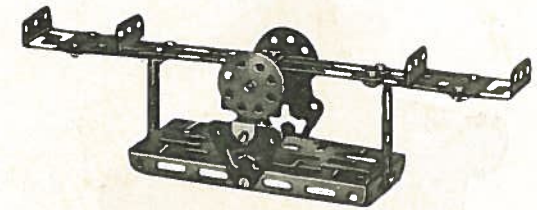

33

35. **Balançoire - Schommel**
Swing - Columpio

Pièces employées
 Gebruikte stukken

1 . . .	N° 1	2 . . .	N° 12
2 . . .	3	1 . . .	16
4 . . .	4	1 . . .	18
2 . . .	5	1 . . .	19
1 . . .	6	2 . . .	29
2 . . .	8	20 . . .	31
2 . . .	9	2 . . .	32

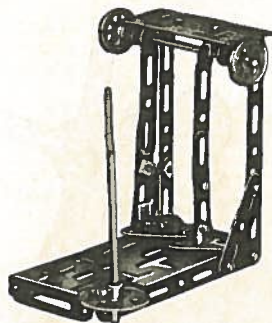

35

36. **Balançoire - Schommel**
Swing - Columpio

Pièces employées
 Gebruikte stukken

1 . . .	N° 1	1 . . .	N° 16
2 . . .	3	2 . . .	29
2 . . .	4	4 . . .	30
2 . . .	5	10 . . .	31
1 . . .	6	2 . . .	32
2 . . .	12	4 . . .	33

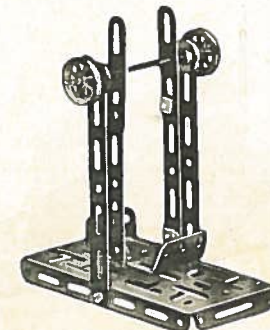

36

37. TANK

Pièces employées
 Gebruikte stukken

1 . . .	N° 1	2 . . .	N° 16
3 . . .	4	4 . . .	19
2 . . .	5	2 . . .	24
2 . . .	6	2 . . .	29
2 . . .	7	31 . . .	31
1 . . .	12	4 . . .	32
1 . . .	15	2 . . .	33

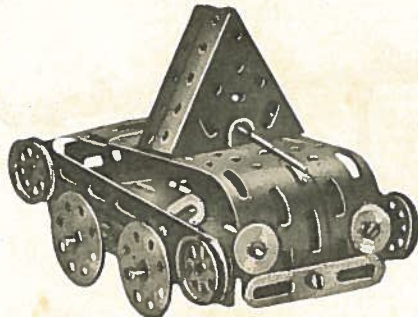

37

40. Yacht - Jacht - Yacht - Yate

Pièces employées
 Gebruikte stukken

1 . . .	N° 1	3 . . .	N° 12
2 . . .	2	1 . . .	13
2 . . .	3	1 . . .	15
7 . . .	4	1 . . .	16
2 . . .	5	1 . . .	19
2 . . .	7	3 . . .	30
1 . . .	8	30 . . .	31
2 . . .	9	2 . . .	32
3 . . .	11	4 . . .	33

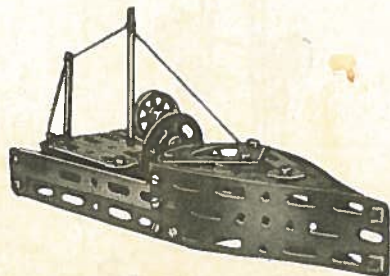

40

**39. Traineau - Slede
 Sleigh - Rastra**

Pièces employées
 Gebruikte stukken

1 . . .	N° 1
2 . . .	2
2 . . .	4
2 . . .	5
10 . . .	31

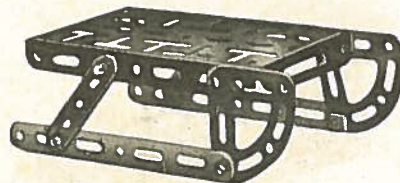

39

**38. Balançoire - Schommel
 Swing - Columpio**

Pièces employées
 Gebruikte stukken

1 . . .	N° 1	4 . . .	N° 12
2 . . .	3	1 . . .	16
4 . . .	4	1 . . .	24
2 . . .	5	16 . . .	31
1 . . .	9	2 . . .	29

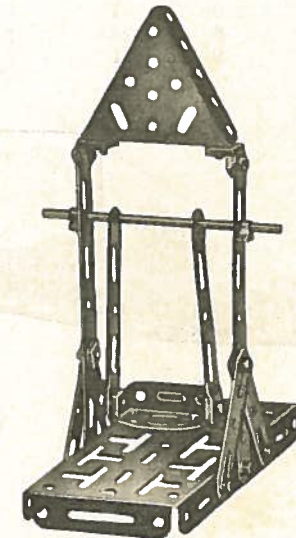

38

**41. Carroussel - Molen - Tilting
 Caballitos ("Carrousel")**

Pièces employées
 Gebruikte stukken

1 . . .	N° 1	1 . . .	N° 18
2 . . .	3	4 . . .	19
6 . . .	4	2 . . .	24
2 . . .	5	1 . . .	30
2 . . .	9	18 . . .	31
1 . . .	15	4 . . .	32
1 . . .	16		

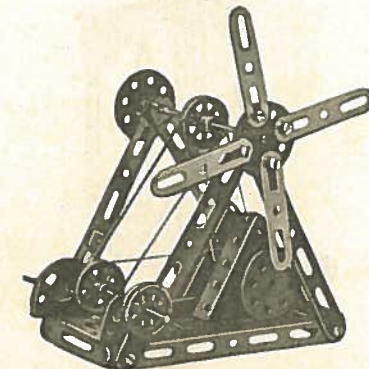

41

42

Grue II - Kraan II
Crane - Grúa

Pièces employées
Gebruikte stukken

1 . . .	N° 1	2 . . .	N° 15
4 . . .	3	2 . . .	16
7 . . .	4	1 . . .	18
2 . . .	5	4 . . .	19
2 . . .	8	2 . . .	24
2 . . .	9	2 . . .	29
2 . . .	10	4 . . .	30
1 . . .	11	29 . . .	31
4 . . .	12	3 . . .	32
2 . . .	13	4 . . .	33

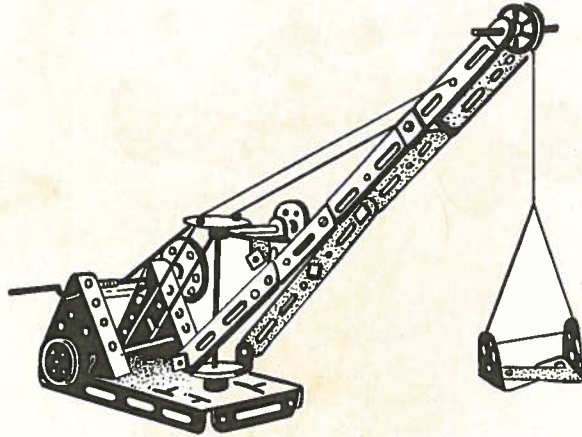

42

45

Moulin - Zwiermolen
Mill - Molino

Pièces employées
Gebruikte stukken

1 . . .	N° 1	2 . . .	N° 12
4 . . .	4	4 . . .	13
2 . . .	5	1 . . .	16
2 . . .	6	1 . . .	18
2 . . .	7	2 . . .	19
2 . . .	8	29 . . .	31
2 . . .	9	2 . . .	32
4 . . .	11		

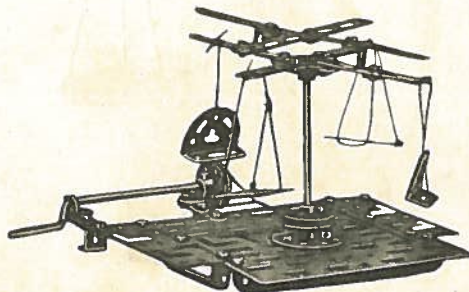

45

44.

Avion - Vliegtuig
Airplane - Aeroplano

Pièces employées
Gebruikte stukken

2 . . .	N° 2	3 . . .	N° 11
4 . . .	3	4 . . .	12
8 . . .	4	4 . . .	13
2 . . .	5	1 . . .	16
2 . . .	6	2 . . .	30
2 . . .	7	33 . . .	31
2 . . .	8	2 . . .	32
1 . . .	9	2 . . .	42

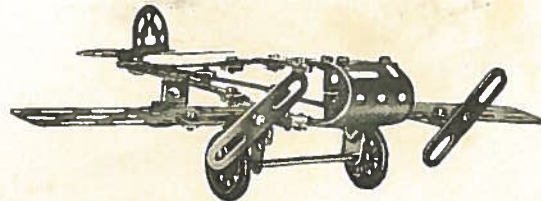

44

43.

Ventilateur - Luchttrekker
Ventilator - Ventilador

Pièces employées
Gebruikte stukken

1 . . .	N° 1	4 . . .	N° 19
2 . . .	3	2 . . .	24
8 . . .	4	2 . . .	29
2 . . .	5	4 . . .	30
2 . . .	7	36 . . .	31
2 . . .	16	4 . . .	32
1 . . .	18	3 . . .	33

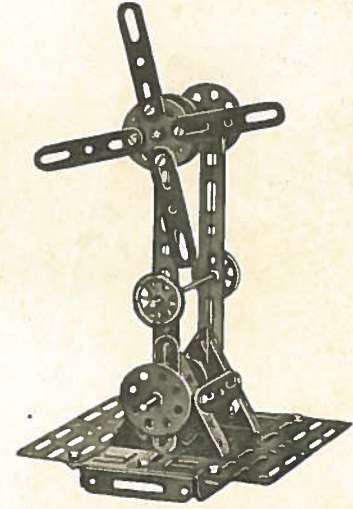

43

46.

Pont-Levis - Ophaalbrug
Draw Bridge - Puente levadizo

Pièces employées
Gebruikte stukken

1 . . .	N° 1	2 . . .	N° 8	1 . . .	N° 18
4 . . .	3	2 . . .	9	2 . . .	30
6 . . .	4	2 . . .	11	24 . . .	31
2 . . .	5	2 . . .	12	4 . . .	32
2 . . .	6	2 . . .	13	4 . . .	33
1 . . .	7	1 . . .	16		

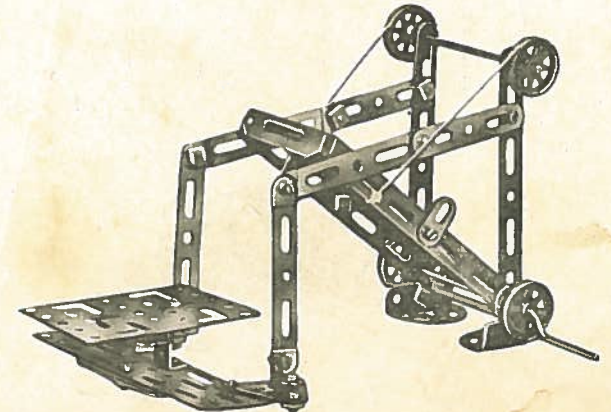

46

47. Locomotive - Locomotief
Engine - Locomotora

Pièces employées
Gebruikte stukken

1 . . .	N° 1	1 . . .	N° 15
2 . . .	3	2 . . .	16
2 . . .	6	4 . . .	30
2 . . .	7	24 . . .	31
2 . . .	8	4 . . .	32
2 . . .	9	4 . . .	33
2 . . .	12		

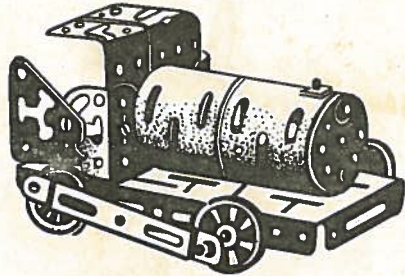

47

49

V. I.

Pièces employées
Gebruikte stukken

4 . . .	N° 3	2 . . .	N° 10
8 . . .	4	4 . . .	11
2 . . .	5	2 . . .	12
2 . . .	6	2 . . .	13
2 . . .	7	30 . . .	31

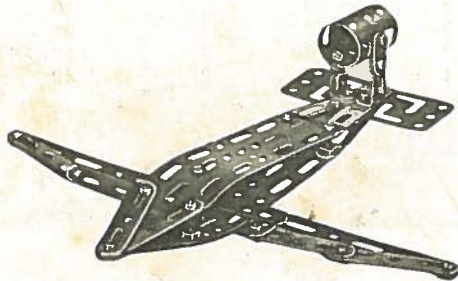

49

50. Chariot - Wagen
Waggon - Carréton

Pièces employées
Gebruikte stukken

1 . . .	N° 1	3 . . .	N° 12
8 . . .	4	2 . . .	16
2 . . .	5	4 . . .	30
2 . . .	6	24 . . .	31
2 . . .	7	4 . . .	32
2 . . .	11	4 . . .	32 P. 1



50

48. Propulseur - Propeller
Propeller - Propulsor

Pièces employées
Gebruikte stukken

2 . . .	N° 3	1 . . .	N° 15
7 . . .	4	1 . . .	16
2 . . .	5	2 . . .	19
1 . . .	9	1 . . .	24
2 . . .	10	4 . . .	30
4 . . .	11	32 . . .	31
4 . . .	12	2 . . .	32
1 . . .	13	2 . . .	32 P. 1

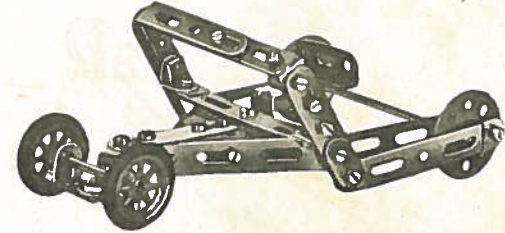

48

51. Balance - Weegschaal
Balance - Balanza

Pièces employées
Gebruikte stukken

1 . . .	N° 1	3 . . .	N° 11
2 . . .	2	2 . . .	12
2 . . .	3	2 . . .	13
7 . . .	4	1 . . .	15
2 . . .	5	2 . . .	19
2 . . .	6	2 . . .	24
2 . . .	7	2 . . .	30
2 . . .	8	33 . . .	31
2 . . .	9		

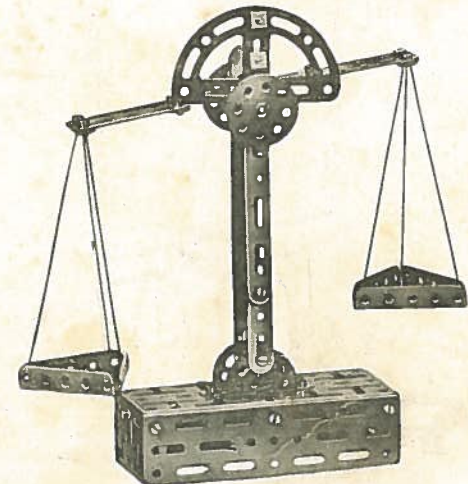

51

52. **Machine à scier**
Zaagmachien
Saw - Maquina para serrar

Pièces employées
 Gebruikte stukken

1 . . .	N° 1	2 . . .	N° 16
2 . . .	2	1 . . .	18
2 . . .	3	4 . . .	19
8 . . .	4	2 . . .	24
2 . . .	5	2 . . .	29
1 . . .	6	3 . . .	30
2 . . .	7	35 . . .	31
2 . . .	9	4 . . .	32
3 . . .	12	2 . . .	33
2 . . .	13		

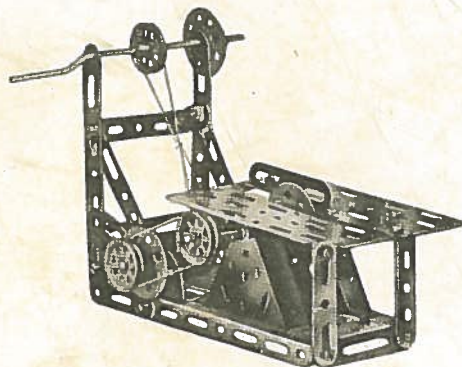

52

55. **Turbine - Droger**
Turbine - Turbina

Pièces employées
 Gebruikte stukken

1 . . .	N° 1	1 . . .	N° 15
1 . . .	7	1 . . .	18
2 . . .	9	2 . . .	19
1 . . .	10	1 . . .	24
1 . . .	11	13 . . .	31
1 . . .	12	2 . . .	32

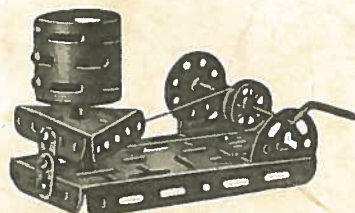

55

54. **Tracteur - Tractor**

Pièces employées
 Gebruikte stukken

1 . . .	N° 1	1	N° 15
3 . . .	4	2 . . .	16
2 . . .	6	4 . . .	19
2 . . .	7	2 . . .	29
1 . . .	9	4 . . .	30
2 . . .	10	28 . . .	31
4 . . .	11	4 . . .	32
4 . . .	12	4 . . .	33
4 . . .	13	2 . . .	32 P. 1

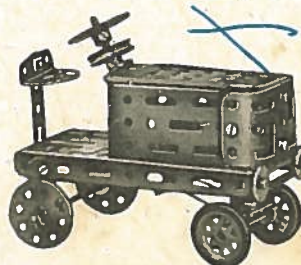

54

53. **Tombereau - Driewielkar**
Tumbrel - Chirrión

Pièces employées
 Gebruikte stukken

1 . . .	N° 1	2	N° 12
2 . . .	3	4 . . .	13
7 . . .	4	2 . . .	15
2 . . .	5	1 . . .	16
2 . . .	6	2 . . .	19
2 . . .	7	4 . . .	30
2 . . .	9	36 . . .	31
2 . . .	10	4 . . .	32
4 . . .	11	4 . . .	32 P. 1

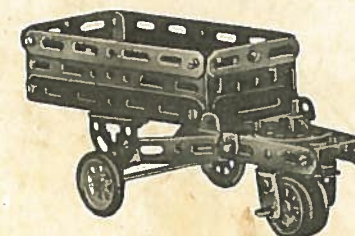

53

56. **Grue tournante**
Mobiele draaikraan
Turn-Crane - Grúa Giratoria

Pièces employées
 Gebruikte stukken

1 . . .	N° 1	1	N° 18
2 . . .	2	4 . . .	19
2 . . .	3	2 . . .	24
7 . . .	4	2 . . .	29
2 . . .	5	4 . . .	30
2 . . .	9	32 . . .	31
2 . . .	12	4 . . .	32
1 . . .	13	4 . . .	33
2 . . .	15	4 . . .	32 P. 1
2 . . .	16		

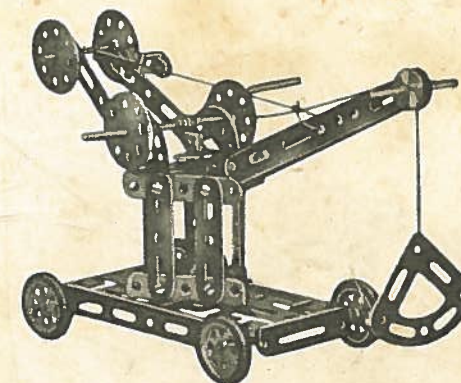

56

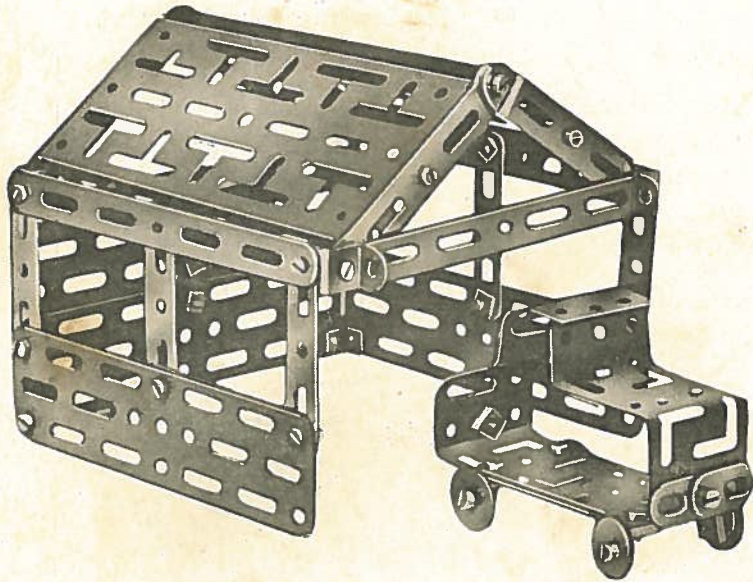

57

57. **Garage avec auto**
Garage met auto
Garage with car
Garage con automóvil
 Pièces employées
 Gebruikte stukken

2 . . .	N° 1
4 . . .	3
6 . . .	4
3 . . .	5
4 . . .	6
4 . . .	7
3 . . .	11
8 . . .	12
2 . . .	13
36 . . .	31
4 . . .	33

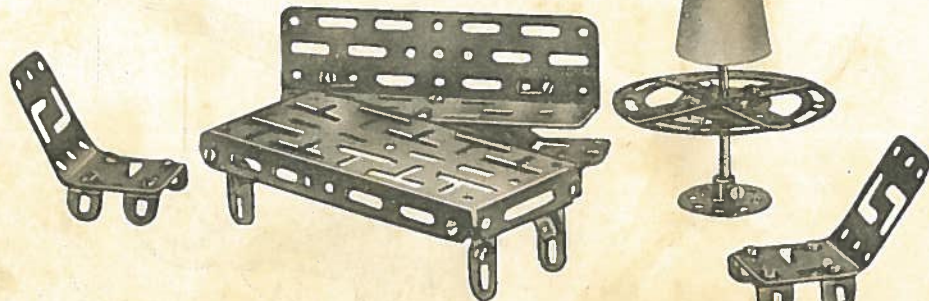

59

59. **SALON**
Loungne-Fourniture
Salon

Pièces employées
 Gebruikte stukken

1 . . .	N° 1
4 . . .	2
4 . . .	6
2 . . .	7
2 . . .	9
4 . . .	11
8 . . .	12
4 . . .	13
1 . . .	16
3 . . .	19
30 . . .	31

58. **Excavateur - Grondwegruimer**
Excavator
Excavador

Pièces employées
 Gebruikte stukken

1 . . .	N° 1
4 . . .	3
1 . . .	4
4 . . .	5
4 . . .	6
2 . . .	7
2 . . .	8
7 . . .	12
1 . . .	15
2 . . .	16
1 . . .	18
4 . . .	19
2 . . .	29
4 . . .	30
36 . . .	31
4 . . .	32
4 . . .	33
4 . . .	32Pl
1 . . .	63

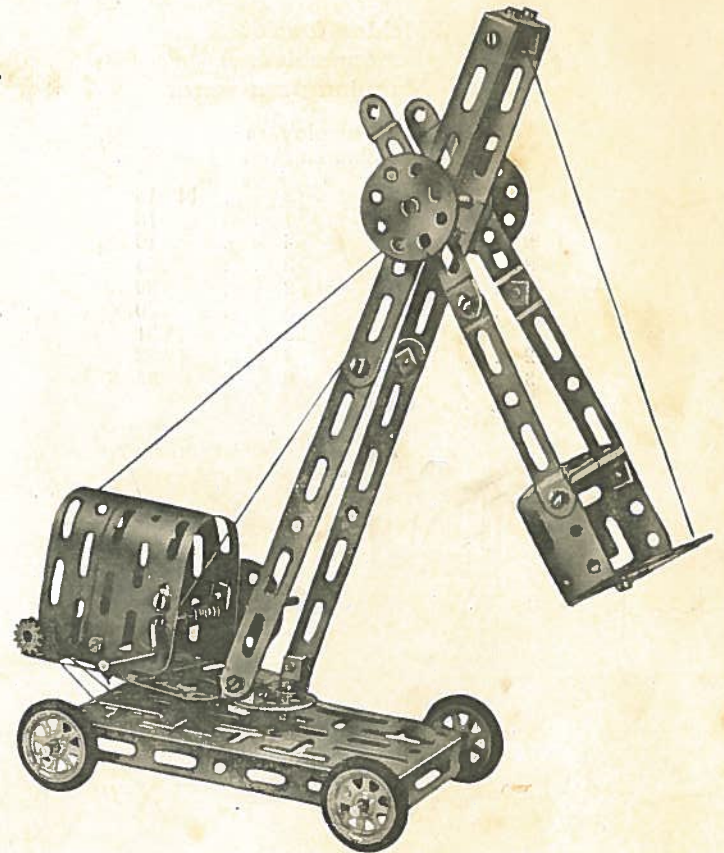

58

60. **Balancoire - Schommel**
Swing
Columpio

Pièces employées
 Gebruikte stukken

1 . . .	N° 1
4 . . .	3
6 . . .	4
4 . . .	5
1 . . .	7
2 . . .	9
2 . . .	12
1 . . .	16
2 . . .	19
1 . . .	18
4 . . .	29
25 . . .	31
2 . . .	32
2 . . .	33
1 . . .	63

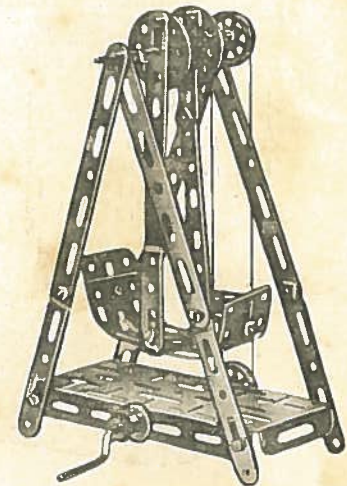

60

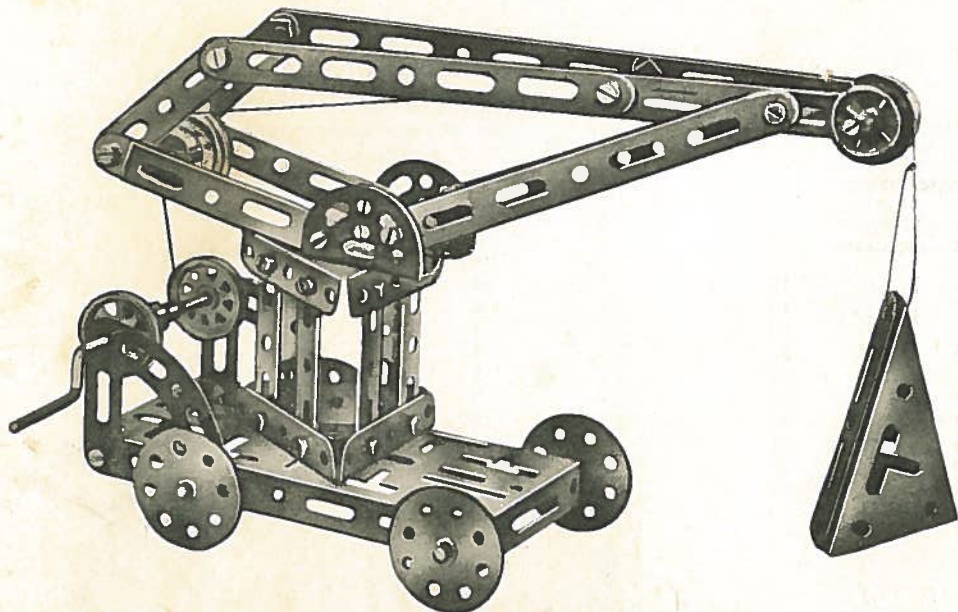

61

61. Grue roulante - Rollende kraan
Roll-Crane
Grua móvil (rodante)

Pièces employées
Gebruikte stukken

1	N° 1	4	N° 19
2	2	2	22
4	3	2	24
8	4	2	29
4	5	4	30
2	9	36	31
2	13	4	32
2	15	2	33
2	16	1	63
1	18		

62. Cheval bascule
Schommel paard
Seesaw-Horse
Caballo de bascula

Pièces employées
Gebruikte stukken

4	N° 2	2	N° 10
4	3	3	11
7	4	8	12
4	6	4	13
2	9	36	31

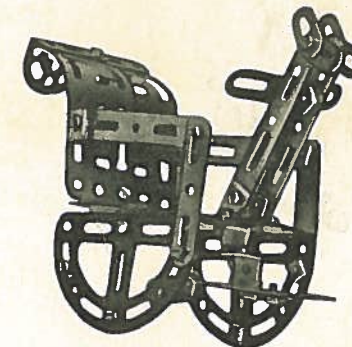

62

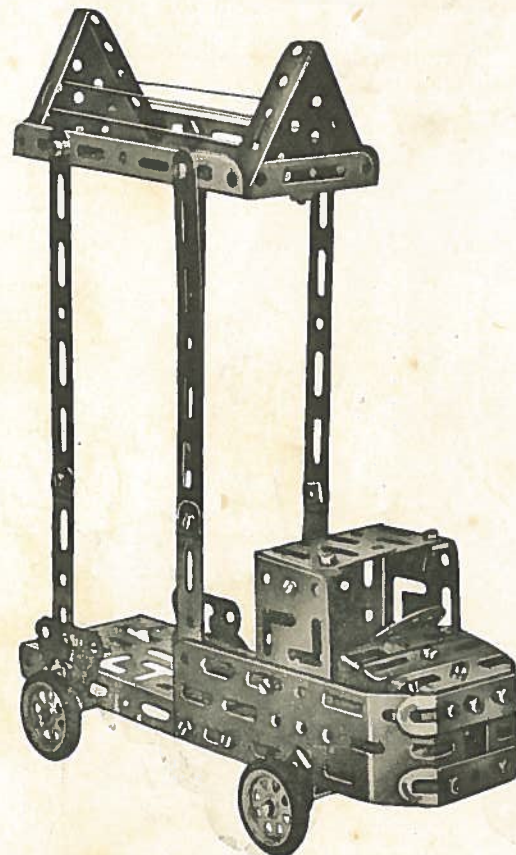

63

63. Dépanneur
Tramlijn Herstelwagen
Repair-Car
Despanador

Pièces employées
Gebruikte stukken

2	N° 1
4	3
5	4
4	5
4	6
4	7
2	8
3	11
1	12
1	15
2	16
1	19
2	24
4	30
36	31
4	32
4	32PI
2	33

64. Grue — Kraan — Crane — Grua
Pièces employées — Gebruikte stukken

2	N° 1	2	N° 8	1	N° 15	2	N° 24
2	4	2	9	2	16	33	31
4	5	1	11	1	18	4	32
2	6	4	12	4	19	2	63

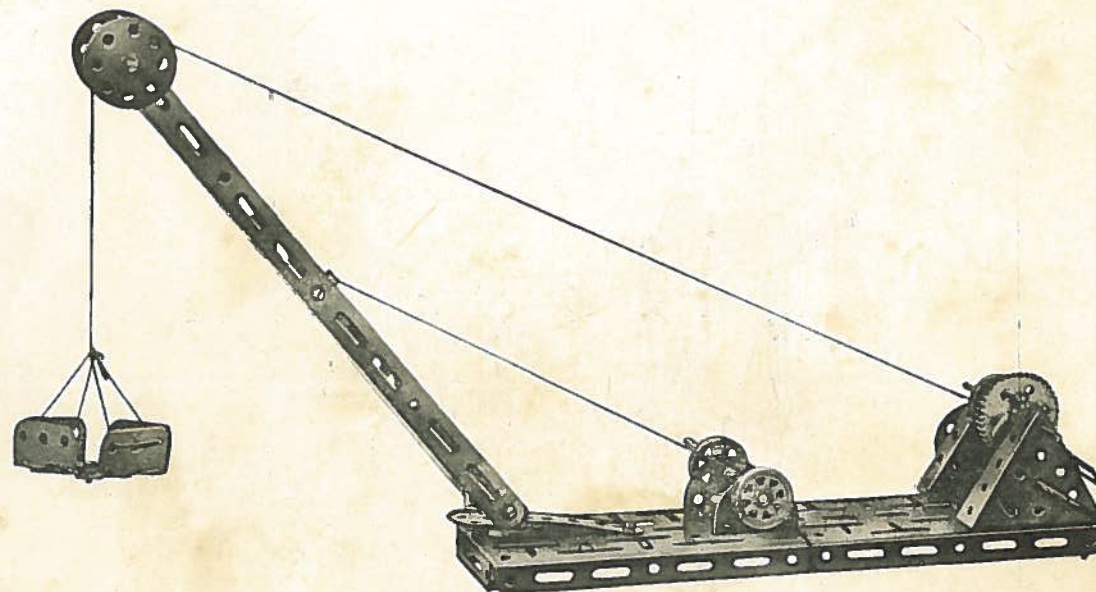

64

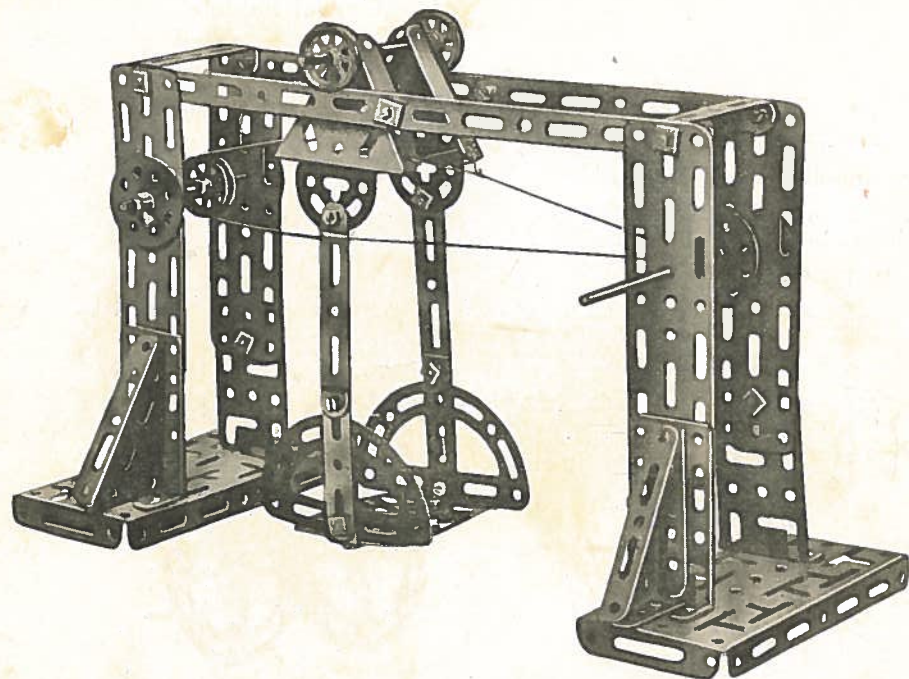

65

65. **Pont Roulant - Rolbrug**
Roll-Bridge
Puente grua

Pièces employées
 Gebruikte stukken

2 .	N° 1	2 .	N° 16
4 .	2	1 .	18
4 .	3	4 .	19
6 .	4	2 .	22
4 .	5	2 .	24
4 .	6	2 .	29
4 .	7	4 .	30
2 .	8	33 .	31
2 .	9	4 .	32
2 .	12	3 .	33

66. **Moto - Triporteur**
Motor with tricycle
Moto - triportador

Pièces employées
 Gebruikte stukken

1 .	N° 1	3 .	N° 13
2 .	2	2 .	15
2 .	3	1 .	16
4 .	4	2 .	19
4 .	6	2 .	29
4 .	7	3 .	30
1 .	8	36 .	31
1 .	9	1 .	32
2 .	10	1 .	32P1
3 .	11	4 .	33
8 .	12		

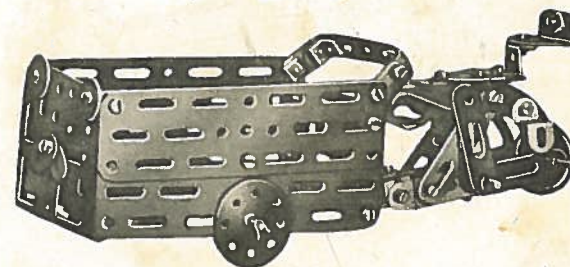

66

67. **Banc de Foreuse - Boorbank**
Bore

Banco de máquina de taladrar

Pièces employées
 Gebruikte stukken

1 .	N° 1	2 .	N° 13
1 .	3	2 .	16
6 .	4	1 .	18
2 .	5	3 .	19
1 .	6	2 .	29
2 .	8	4 .	30
2 .	9	34 .	31
2 .	11	4 .	32
8 .	12	3 .	33

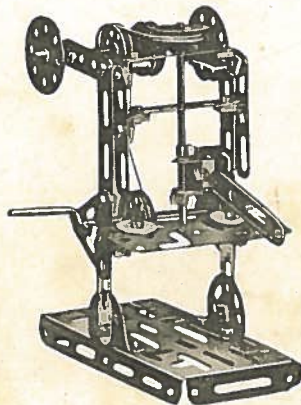

67

68. **Tracteur et Charrue**
Tractor met ploeg
Tractor with plough
Tractor y arado

Pièces employées
 Gebruikte stukken

1 .	N° 1	4 .	N° 6	7 .	N° 12	2 .	N° 30
1 .	2	2 .	8	4 .	13	36 .	31
2 .	3	1 .	9	2 .	15	4 .	32
1 .	4	2 .	10	2 .	16	4 .	33
2 .	5	4 .	11	4 .	19	1 .	63

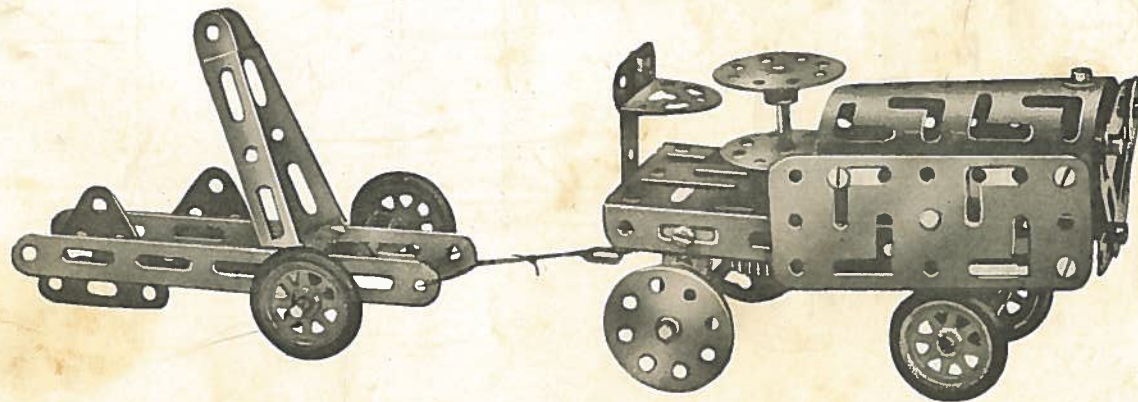

68

69.

**Ascenseur - Lift
Ascensor**

Pièces employées
Gebruikte stukken

1	N° 1
4	3
8	4
4	5
3	6
4	7
2	8
2	9
4	12
4	13
1	15
1	18
3	19
2	29
36	31
2	33

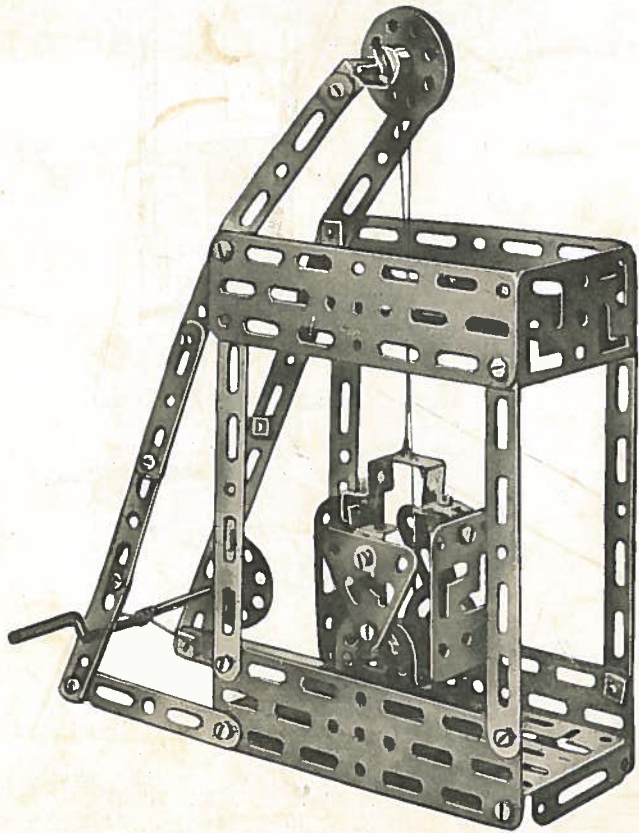

69

70.

**Auto - Tank
Tank-Car
Automóvil-tank**

Pièces employées
Gebruikte stukken

2	N° 1	2	N° 9	1	N° 13	32	N° 31
1	3	2	10	2	16	4	32
4	6	2	11	2	19	2	32PI
4	7	2	12	2	30	2	33

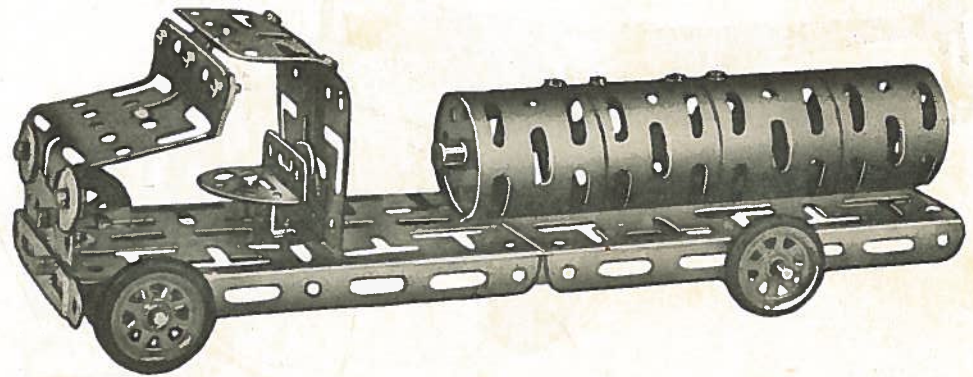

70

71.

**Canon Anti-Tank
Anti tank-kanon
Canon de tiro antitank**

Pièces employées
Gebruikte stukken

1	N° 1	4	N° 5	4	N° 11	2	N° 15	4	N° 19	36	N° 31
4	3	4	6	7	12	2	16	2	29	2	32
4	4	1	10	4	13	1	18	4	30	4	33
										1	63

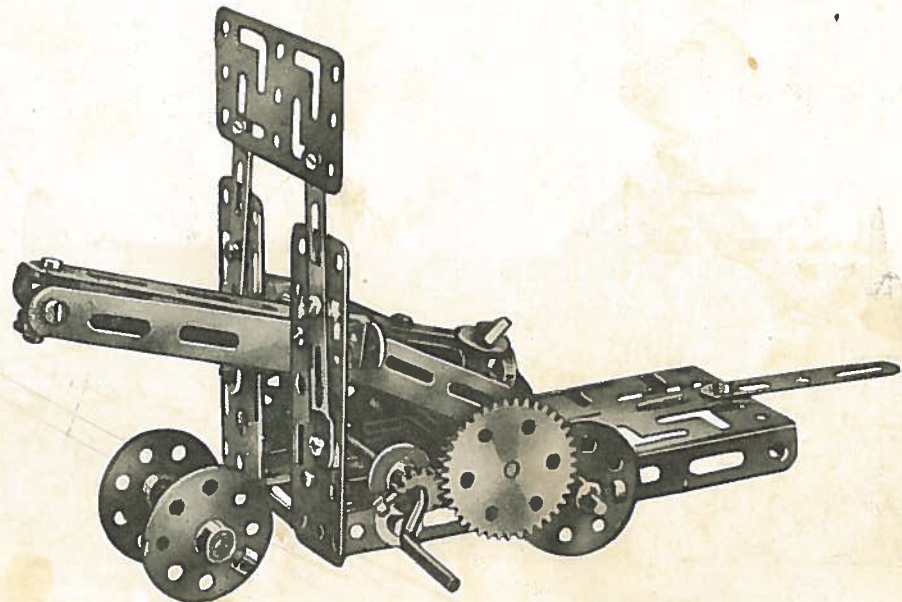

71

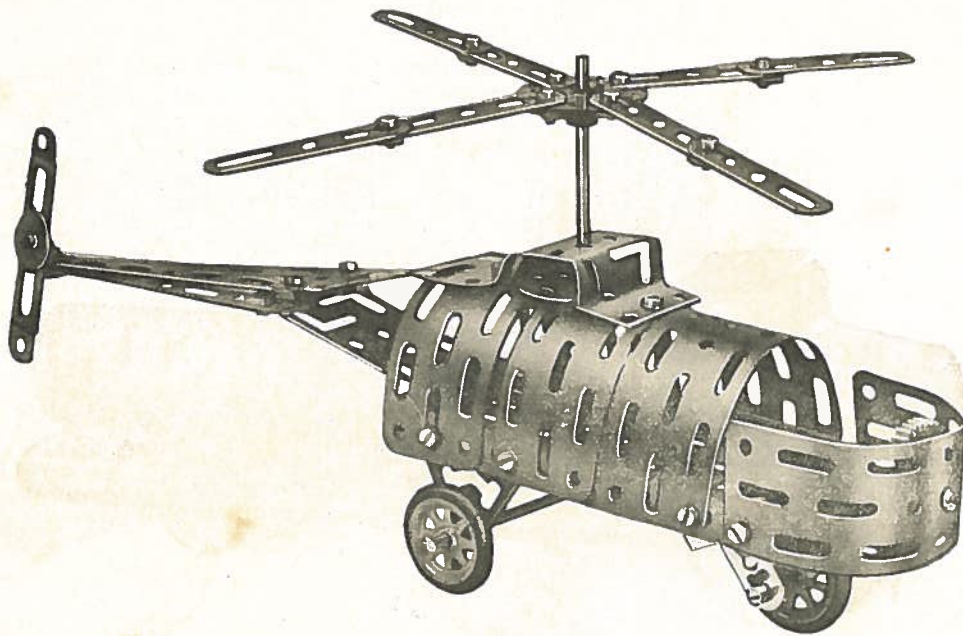

72

72. **Helicoptère**
Heischroefvliegtuig
Helicopter - Helicoptero
 Pièces employées
 Gebruikte stukken

1	N° 1	2	N° 13
1	3	1	16
8	4	3	19
4	5	2	29
3	6	36	31
4	7	2	32
2	8	1	33
2	9	2	32PI
2	11	1	63
1	12		

74. **Tram électrique - Electric tram**
Tramway
Tramvia electrica
 Pièces employées
 Gebruikte stukken

2	N° 1	4	N° 7	2	N° 29
4	2	2	9	4	30
4	3	4	11	34	31
8	4	4	12	4	32
4	5	4	13	1	33
4	6	2	15	1	63

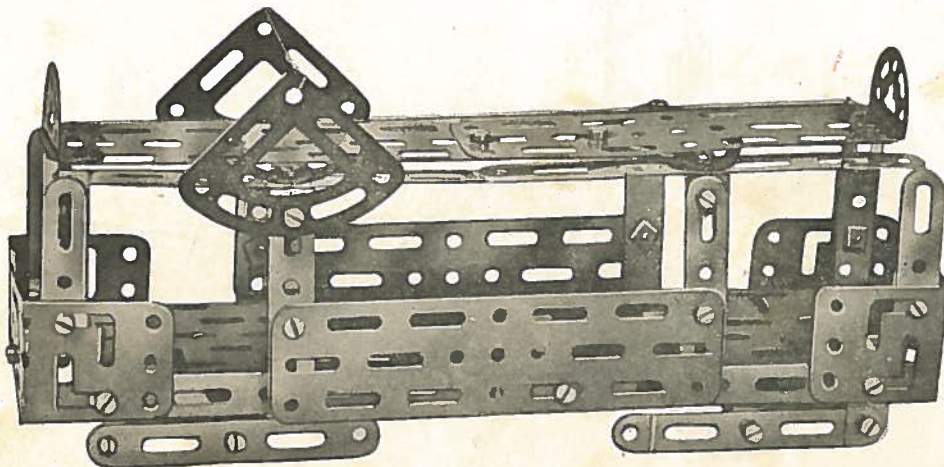

74

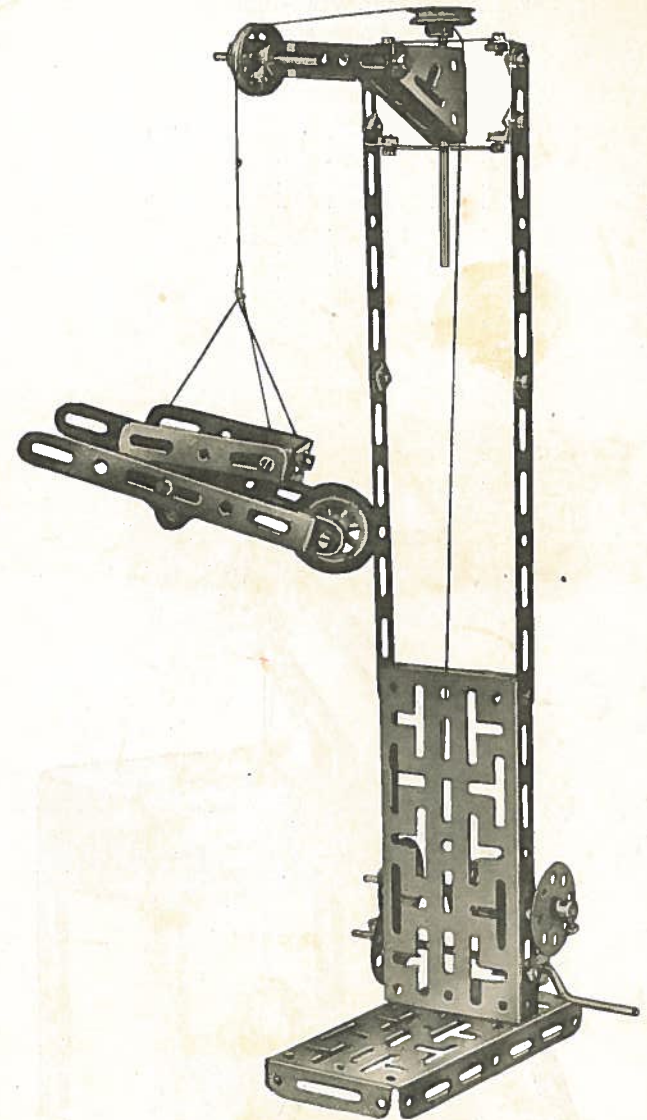

73

73. **Elevateur - Heistoestel**
Hoister
Elevador

Pièces employées					
Gebruikte stukken					
2	N° 1	2	N° 13	36	N° 31
4	3	2	16	4	32
6	4	1	18	1	32PI
4	5	3	19	4	33
1	6	2	22	1	63
4	11	2	29		
6	12	1	30		

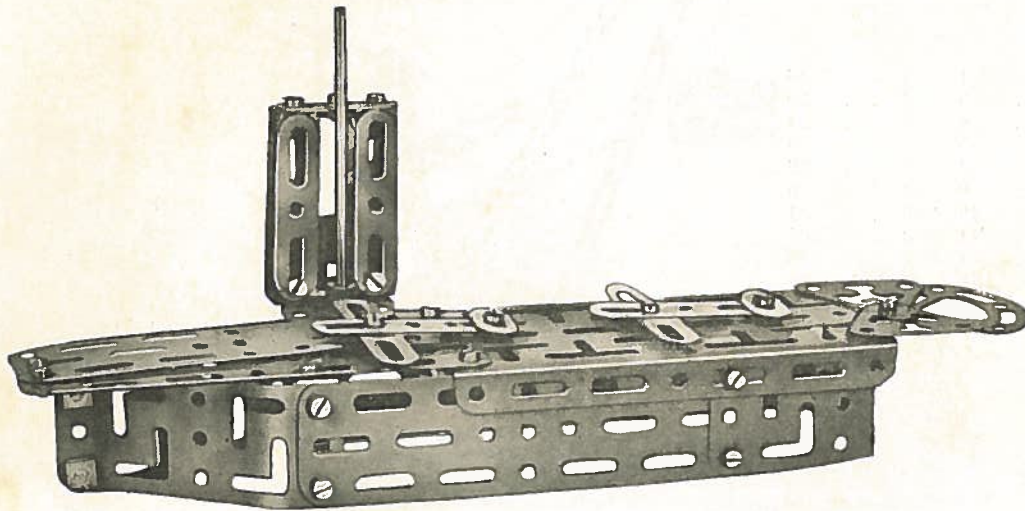

75

75

Porte - Avions
Vliegtuig moederschip
Airplane - Carrier
Portaaviones

Pièces employées
 Gebruikte stukken

1	.	.	.	N° 1
1	.	.	.	2
8	.	.	.	4
4	.	.	.	6
4	.	.	.	7
2	.	.	.	8
2	.	.	.	9
2	.	.	.	10
2	.	.	.	11
4	.	.	.	12
1	.	.	.	16
1	.	.	.	19
35	.	.	.	31

76.

Destroyer

Pièces employées
 Gebruikte stukken

2	.	.	.	N° 1
2	.	.	.	2
4	.	.	.	3
4	.	.	.	5
4	.	.	.	6
4	.	.	.	7
2	.	.	.	9
2	.	.	.	11
4	.	.	.	12
2	.	.	.	13
2	.	.	.	15
2	.	.	.	16
3	.	.	.	19
2	.	.	.	29
30	.	.	.	31

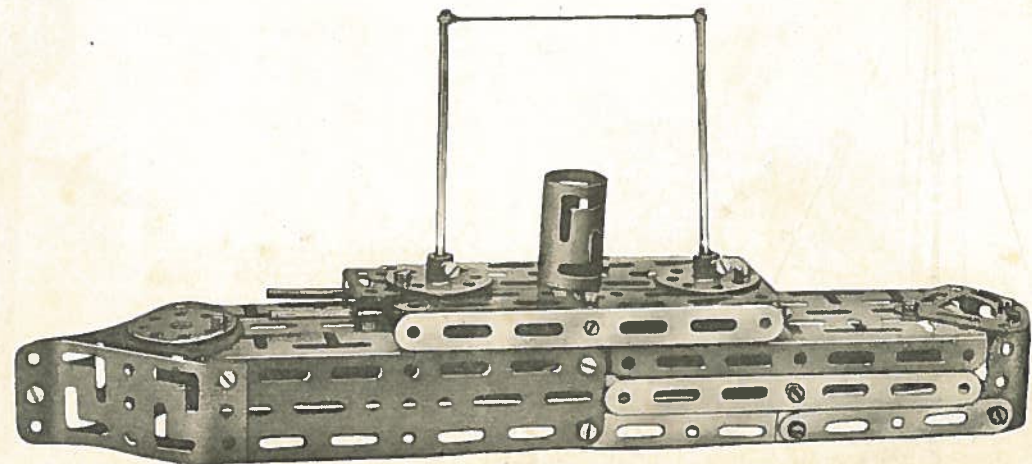

76

77. TANK

Pièces employées — Gebruikte stukken

2 . . . N° 1	2 . . . N° 6	2 . . . N° 15	4 . . . N° 21	48 . . . N° 31
4 . . . 2	3 . . . 7	2 . . . 15F	2 . . . 22	4 . . . 32
3 . . . 3	2 . . . 8	2 . . . 16	2 . . . 25	1 . . . 33
5 . . . 4	2 . . . 9	2 . . . 16F	2 . . . 27F	1 . . . 34
4 . . . 4C	3 . . . 11	4 . . . 19	4 . . . 29	1 . . . 35
4 . . . 5	2 . . . 12	1 . . . 20	4 . . . 30	2 . . . 44

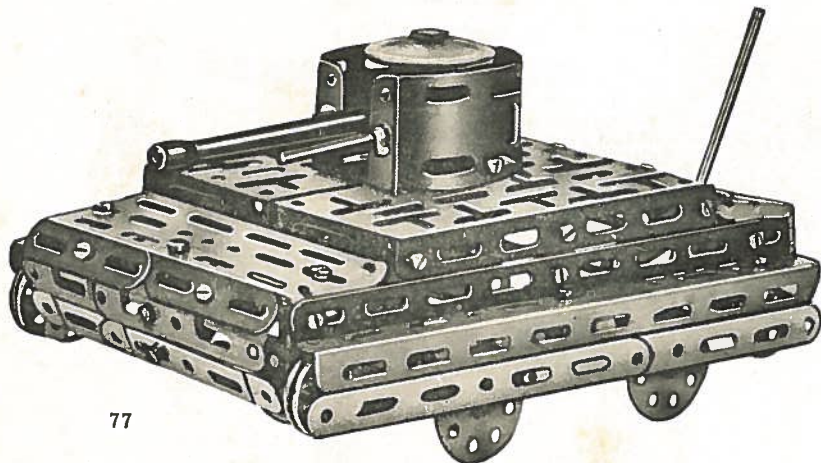

77

79. Bateau — Schip — Ship — Buque

Pièces employées — Gebruikte stukken

2 . . . N° 1	4 . . . N° 4C	1 . . . N° 13	42 . . . N° 31
1 . . . 2	4 . . . 6	2 . . . 16F	1 . . . 34
1 . . . 3	4 . . . 7	4 . . . 21	2 . . . 44
8 . . . 4	5 . . . 12	1 . . . 27F	1 . . . 63

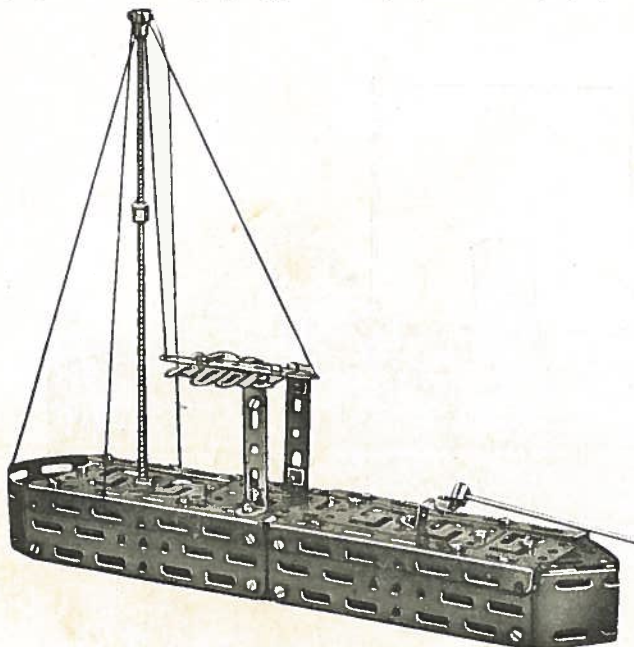

79

78. Auto avec grue
 Autokraan - Crane-Car
 Automovile con grua.

Pièces employées
 Gebruikte stukken

2 . . . N° 1	1 . . . N° 18
4 . . . 3	4 . . . 20
5 . . . 4	2 . . . 24
4 . . . 5	2 . . . 25
4 . . . 6	4 . . . 29
2 . . . 9	4 . . . 30
1 . . . 10	40 . . . 31
4 . . . 11	3 . . . 32
1 . . . 13	2 . . . 33
2 . . . 15F	1 . . . 35
2 . . . 16	1 . . . 63
2 . . . 16F	

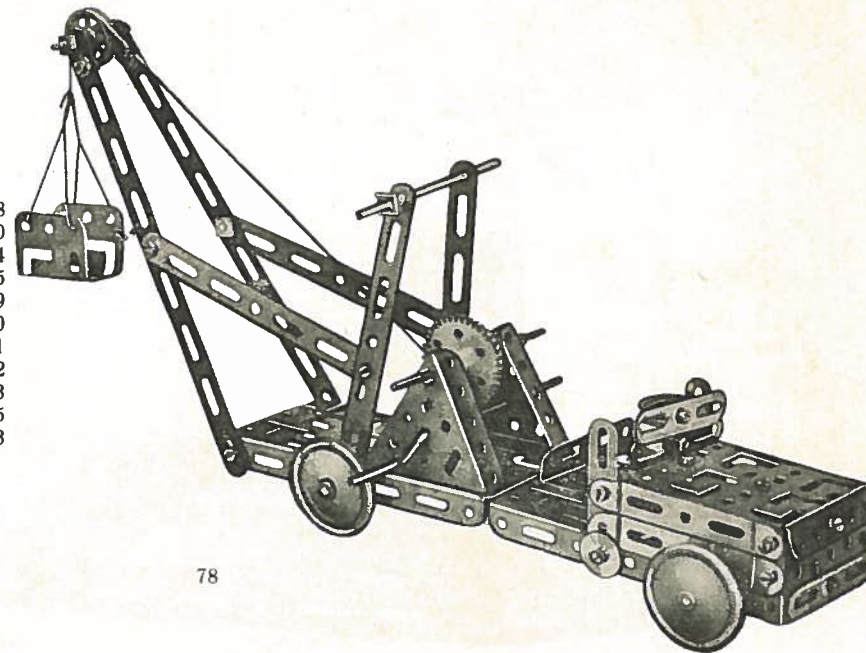

78

80. Elevateur - Ophaalbak - Hoister - Elevador

Pièces employées — Gebruikte stukken

2 . . . N° 1	3 . . . N° 12	3 . . . N° 30
4 . . . 3	2 . . . 16	24 . . . 31
8 . . . 4	1 . . . 18	4 . . . 32
3 . . . 6	4 . . . 21	1 . . . 35
3 . . . 11	3 . . . 29	1 . . . 63

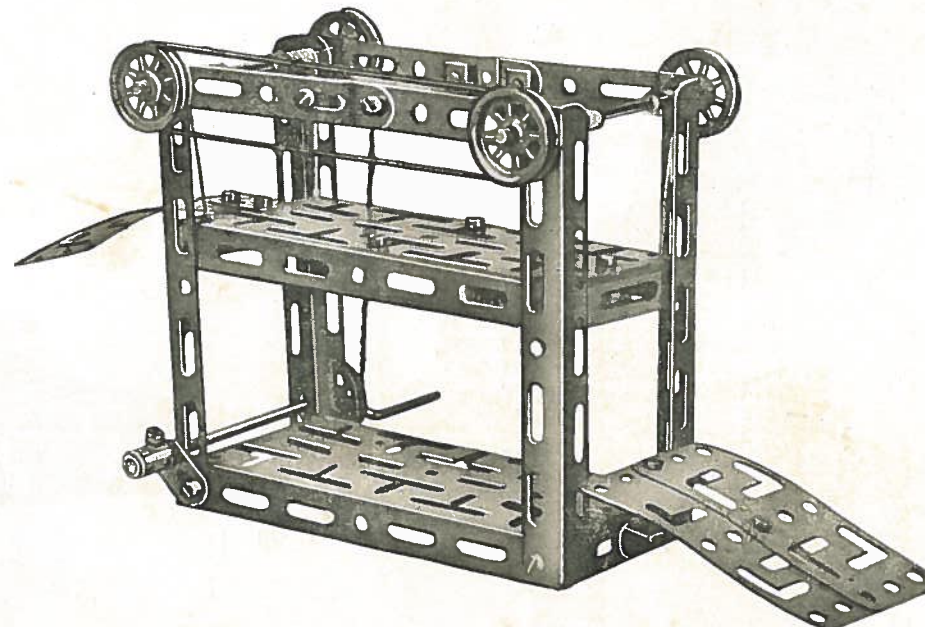

80

81. Carroussel (chevaux) - Paardjesmolen - Tilting - Caballitos (Carrousel)

Pièces employées — Gebruikte stukken

2 . . . N° 1	4 . . . N° 6	2 . . . N° 12	2 . . . N° 22	3 . . . N° 32
1 . . . 3	4 . . . 7	2 . . . 16	2 . . . 24	1 . . . 33
8 . . . 4	2 . . . 9	1 . . . 18	1 . . . 29	1 . . . 63
4 . . . 5	2 . . . 11	3 . . . 19	37 . . . 31	

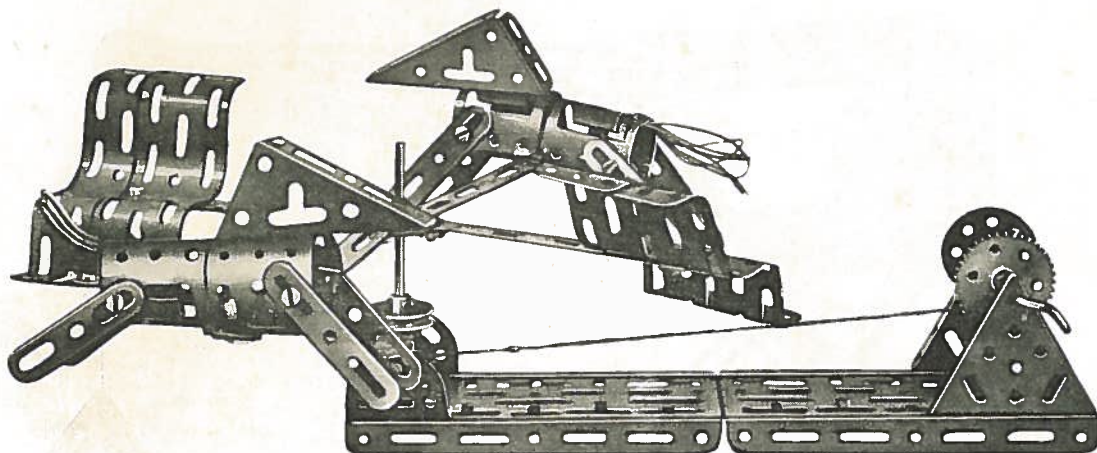

81

82. Grue - Kraan - Crane - Grua

Pièces employées — Gebruikte stukken

2 . . . N° 1	2 . . . N° 8	2 . . . N° 15	2 . . . N° 25	1 . . . N° 34
2 . . . 3	2 . . . 9	2 . . . 15F	4 . . . 29	1 . . . 35
4 . . . 4	2 . . . 10	1 . . . 16	4 . . . 30	1 . . . 63
1 . . . 4C	2 . . . 11	1 . . . 18	48 . . . 31	
4 . . . 5	8 . . . 12	2 . . . 19	5 . . . 32	
4 . . . 7	4 . . . 13	4 . . . 21	4 . . . 33	

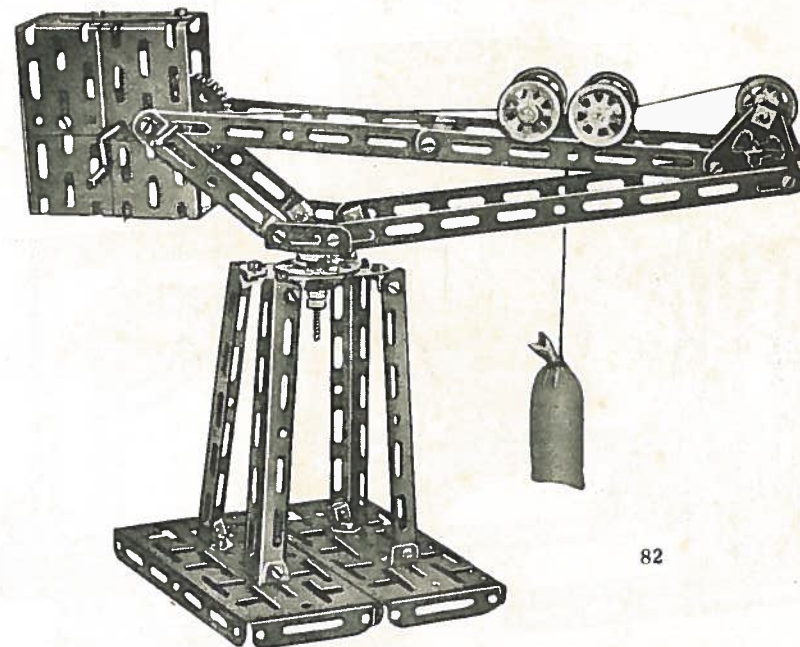

82

83. Croiseur - Kruiser - Crucero

Pièces employées — Gebruikte stukken

2 . . . N° 1	1 . . . N° 8	3 . . . N° 19	3 . . . N° 32
4 . . . 3	2 . . . 9	4 . . . 20	3 . . . 33
7 . . . 4	1 . . . 13	4 . . . 21	1 . . . 34
4 . . . 4C	2 . . . 15	2 . . . 24	1 . . . 35
4 . . . 5	2 . . . 15F	1 . . . 27	2 . . . 44
4 . . . 6	1 . . . 16	1 . . . 29	
4 . . . 7	1 . . . 16F	48 . . . 31	

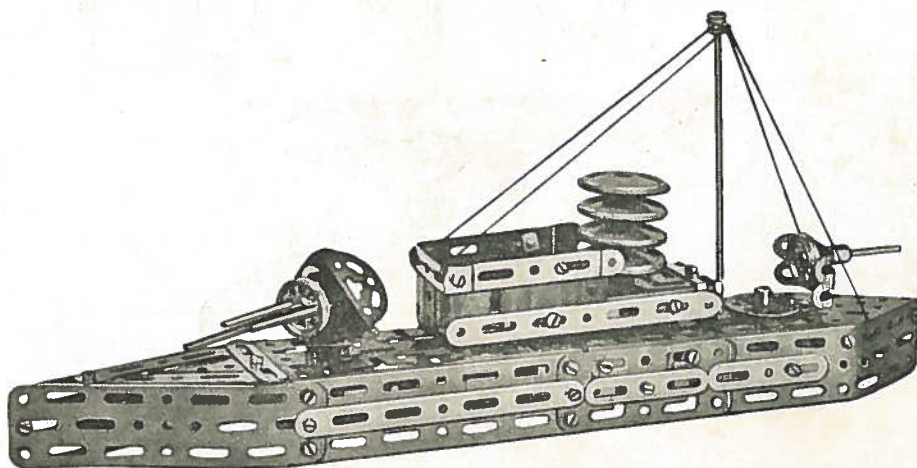

83

84. Aspirateur - Luchttrekker
Aspirator - Aspirador

Pièces employées — Gebruikte stukken

2 . . . N° 1
2 . . . 2
4 . . . 3
2 . . . 5
1 . . . 8
5 . . . 12
2 . . . 13
2 . . . 16
1 . . . 18
2 . . . 19
1 . . . 20
4 . . . 21
2 . . . 24
4 . . . 30
40 . . . 31
4 . . . 32
1 . . . 33
1 . . . 35
1 . . . 63

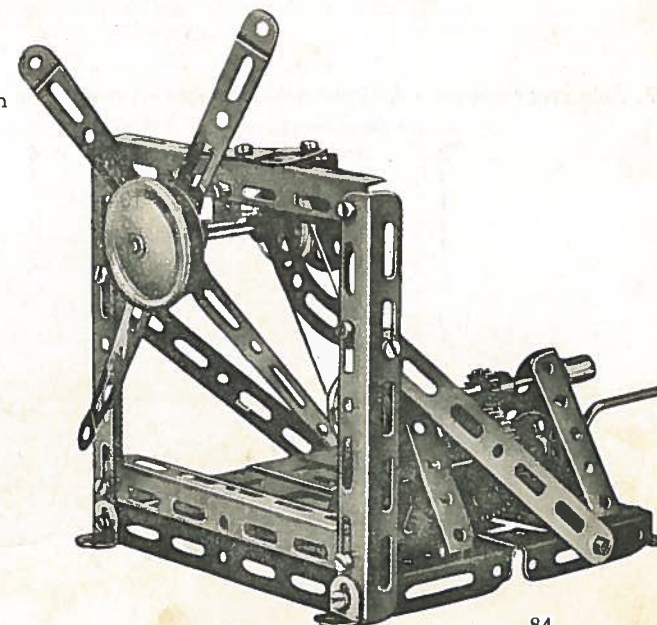

84

85. Tamis à Charbon - Kolenzifter - Coal-Sifter - Tamizador para carbon

Pièces employées - Gebruikte stukken							
2	N° 1	4	N° 6	1	N° 18	48	N° 31
4	2	4	7	1	19	3	32
4	3	2	9	4	21	4	33
8	4	2	13	2	24	1	34
4	4C	1	15F	2	25	1	35
4	5	2	16	4	29	2	44
2	5C2	2	16F	4	30	1	63

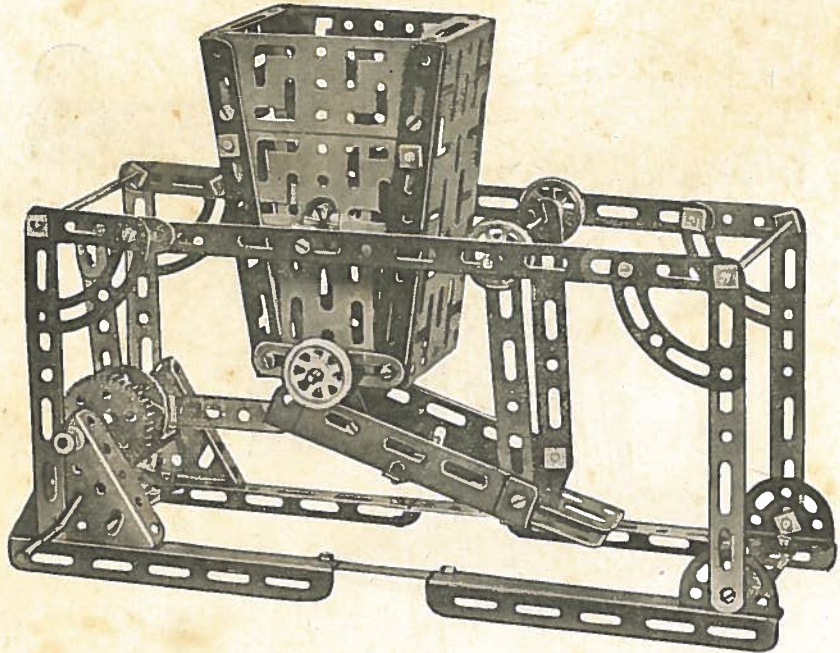

85

87. Auto avec remorque - Auto met aanhangwagen - Car with Trailer - Automovile con remolque

Pièces employées - Gebruikte stukken							
2	N° 1	2	N° 11	4	N° 20		
4	3	6	12	4	21		
1	4	1	13	37	31		
4	6	1	15F	5	32		
4	7	2	16	1	35		
2	8	2	16F	4	32PI		
2	9	1	18	1	63		

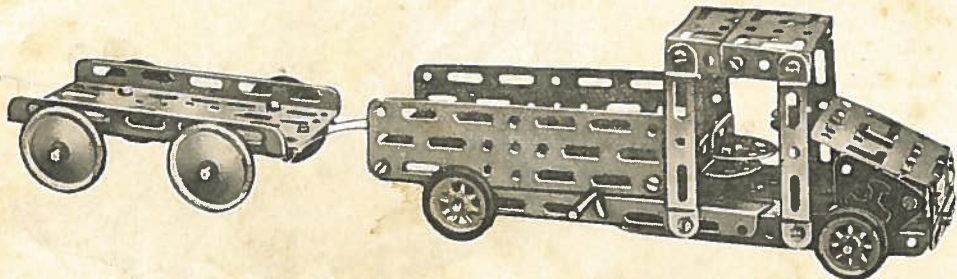

87

86. Grue roulante - Rollende kraan - Roll-Crane - Grua movil (rodante)

Pièces employées - Gebruikte stukken											
2	N° 1	4	N° 5	2	N° 13	4	N° 20	2	N° 27F	4	N° 32
4	2	2	6	2	15	4	21	2	29	4	33
4	3	2	9	1	15F	2	24	4	30	1	34
4	4	4	12	1	18	2	25	47	31	1	35
										1	63

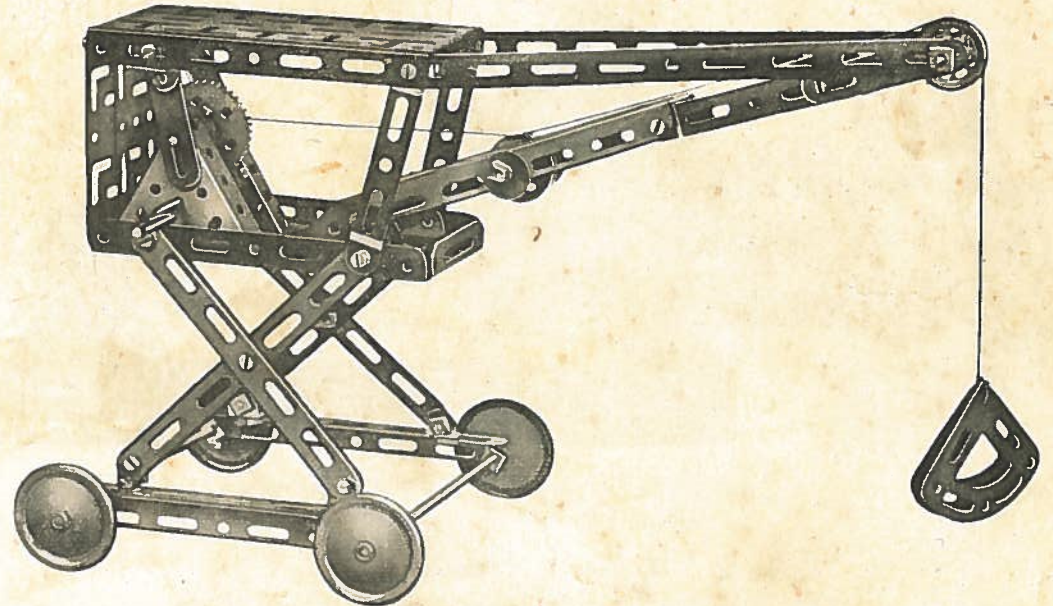

86

88. Auto pompier - Pompier auto - Fire Engine - Automovile para bombero

Pièces employées - Gebruikte stukken											
2	N° 1	2	N° 5C2	4	N° 11	1	N° 16F	2	N° 25	4	N° 33
3	3	4	6	8	12	1	18	2	29	1	35
8	4	2	7	2	13	2	20	4	30	2	32PI
2	4C	2	9	1	15F	2	21	44	31	1	63
4	5	2	10	2	16	2	24	4	32		

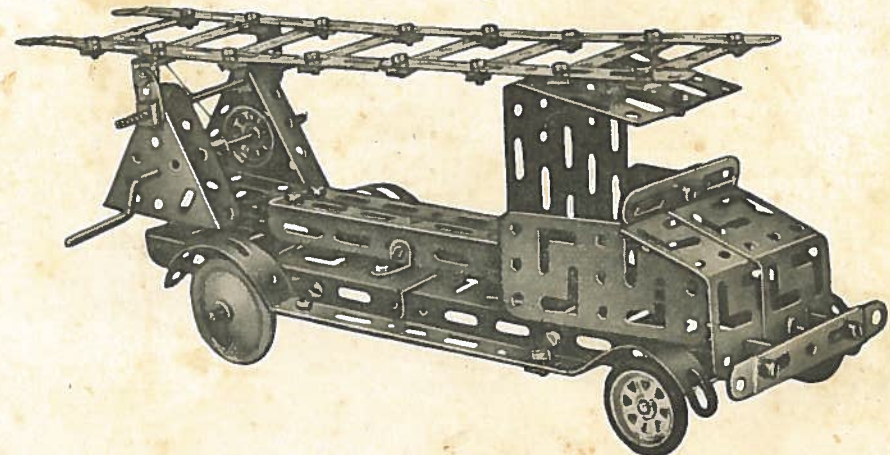

88

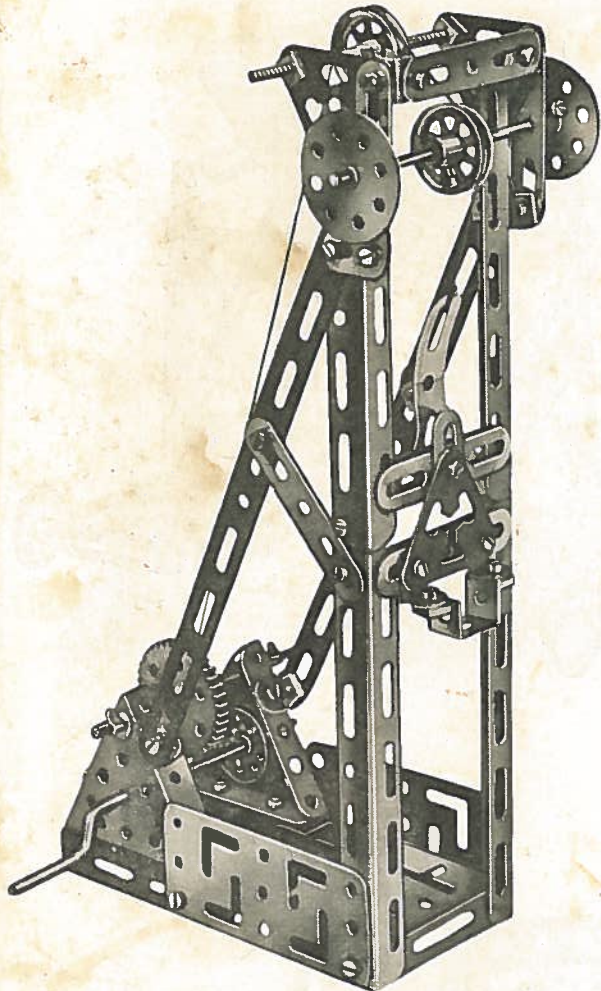

89. Monte-charge - Heisstelling
Hoister - Monta-carga

Pièces employées
Gebruikte stukken

1	..	N° 1
8	..	4
3	..	4C
2	..	6
3	..	8
1	..	10
2	..	11
6	..	12
2	..	13
2	..	16
1	..	16F
1	..	18
2	..	19
4	..	21
2	..	24
2	..	25
4	..	29
4	..	30
41	..	31
4	..	32
4	..	33
1	..	35
1	..	63

89

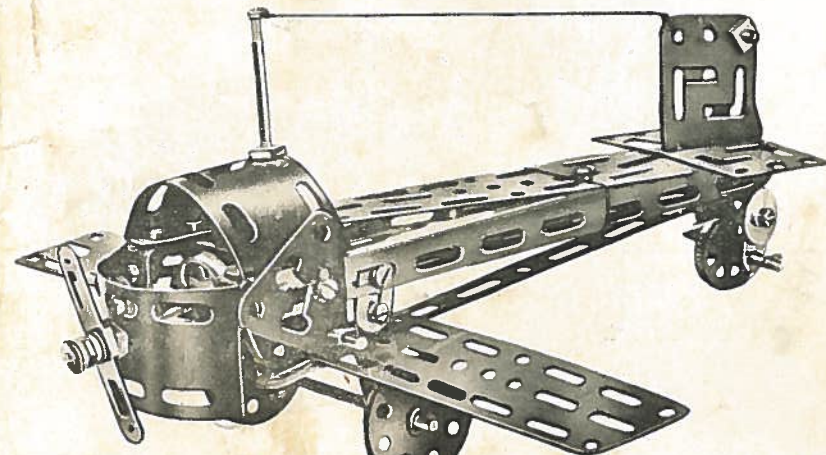

91

91. Avion de reconnaissance
Verkenningsvliegtuig
Observation-Plane
Avion de reconocimiento

Pièces employées - Gebruikte stukken

2	..	N° 4	2	..	16F
1	..	5	3	..	19
2	..	6	4	..	21
3	..	7	2	..	25
2	..	8	4	..	29
3	..	10	4	..	30
4	..	11	38	..	31
8	..	12	4	..	32
1	..	13	4	..	33
2	..	15F	1	..	34
1	..	16	2	..	44

90. Avion de chasse - Jachtvliegtuig - Fighter - Avion de casa

Pièces employées - Gebruikte stukken

1	..	N° 2	4	..	N° 6	1	..	N° 16	48	..	N° 31
4	..	3	4	..	7	1	..	19	2	..	32
8	..	4	2	..	10	1	..	20	1	..	33
1	..	4C	1	..	11	4	..	21	2	..	32PI
4	..	5	7	..	12	1	..	25			
2	..	5C2	1	..	15F	4	..	30			

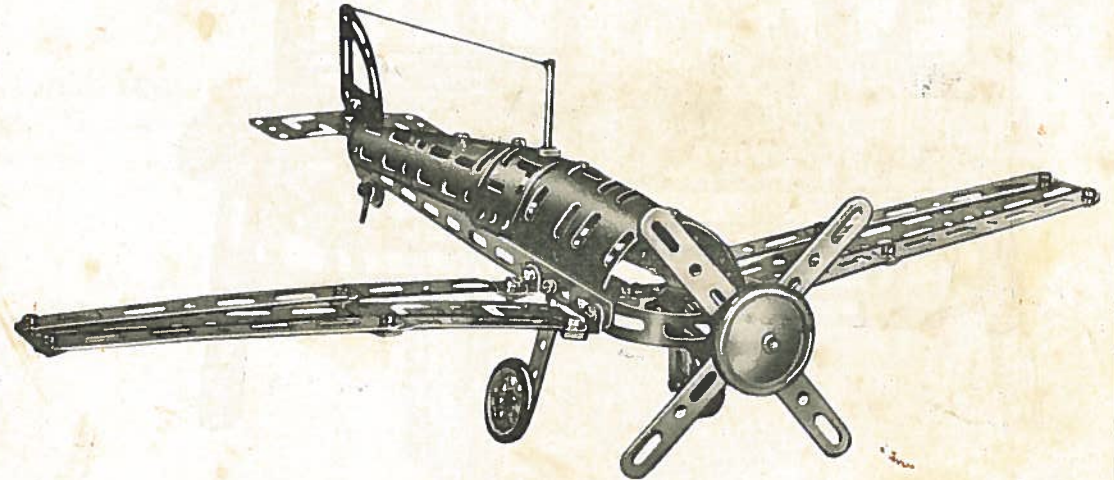

90

92. Auto de course - Koersauto - Racer - Automovile de carrera

Pièces employées - Gebruikte stukken

1	..	N° 1	2	..	N° 9	4	..	N° 29
1	..	2	3	..	11	3	..	30
4	..	3	5	..	12	37	..	31
3	..	4	1	..	15F	5	..	32
1	..	4C	2	..	16	4	..	32PI
4	..	6	2	..	24			

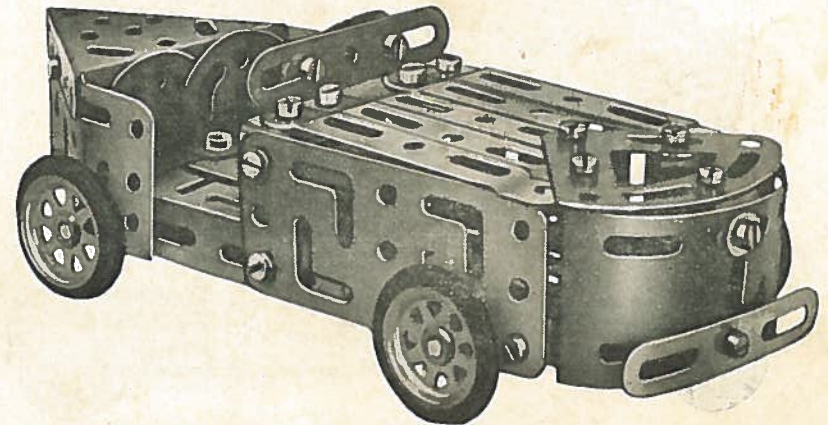

92

93. **Tour - Draaibank - Lathe - Torno**

Pièces employées - Gebruikte stukken

2	N° 1	1	9	2	16	2	25	1	34
4		3	11	1	16F	4	30	1	35
4		7	12	2	19	48	31	2	32P1
2		3	13	2	21	5	32	1	63
1		6	15F	2	24	4	33		

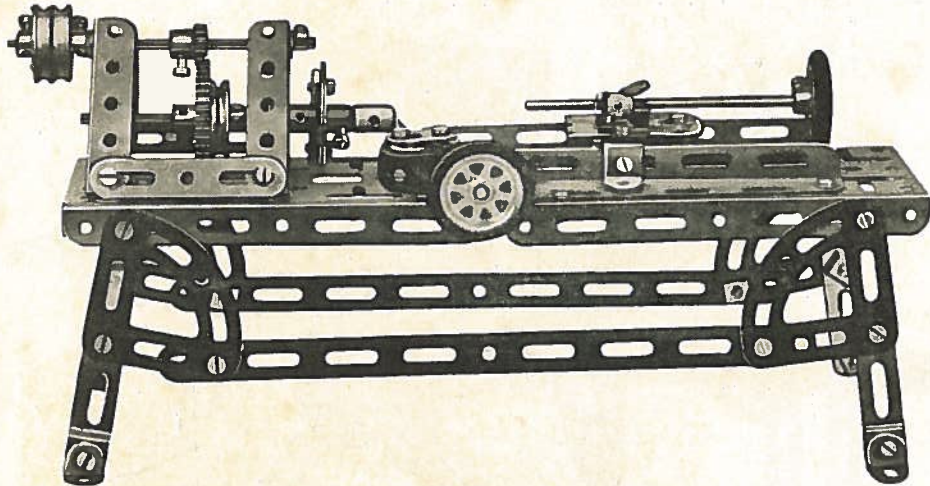

93

94. **SILO**

Pièces employées - Gebruikte stukken

2	N° 1								
4									
4									
4									
2									
2	5C2								
4									
4									
2									
8									
2									
2									
2	15F								
1									
4									
2									
4	27F								
4									
4									
48									
4									
4									
4	32P1								
1									
1									

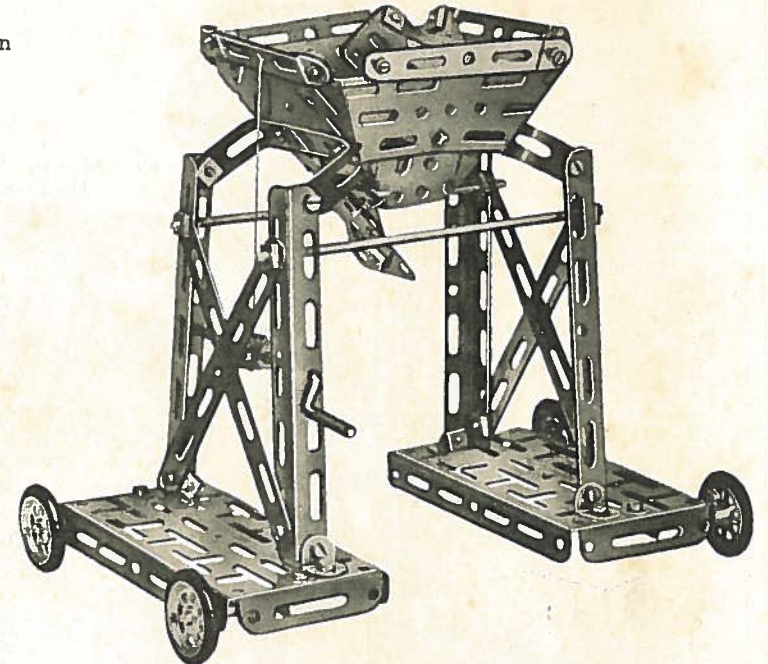

94

95. **Transporteur - Overbrenger - Transporter - Transportador**

Pièces employées - Gebruikte stukken

2	N° 1	2	9	2	16	2	24	1	35
2		2	11	2	16F	4	29	1	63
4		4	12	1	18	4	30		
4	4C	4	13	4	19	48	31		
4		2	15	4	20	5	32		
4		7	15F	4	21	4	33		

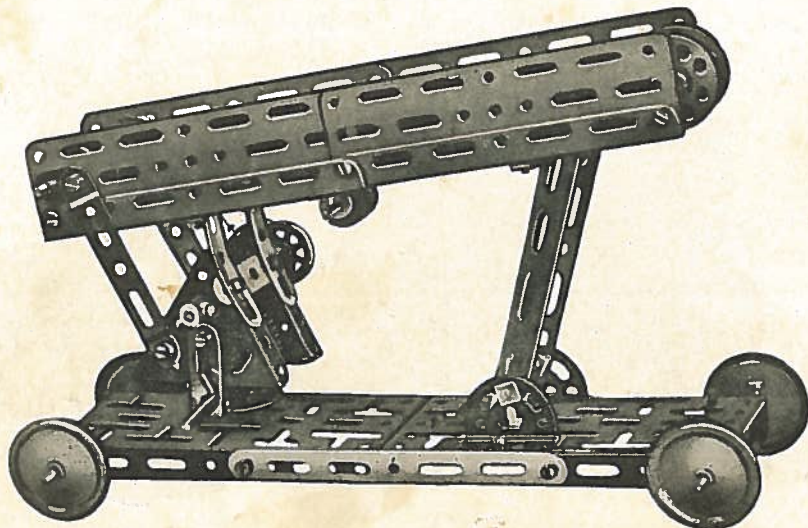

95

96. **Batteuse à lin
Bootmachien
Flax-Beater
Trilladora de lino**

Pièces employées - Gebruikte stukken

1	N° 1								
2									
2									
6									
4									
4									
4									
4									
8									
4									
1									
1									
1									
4									
4									
4									
44									
2									
1									

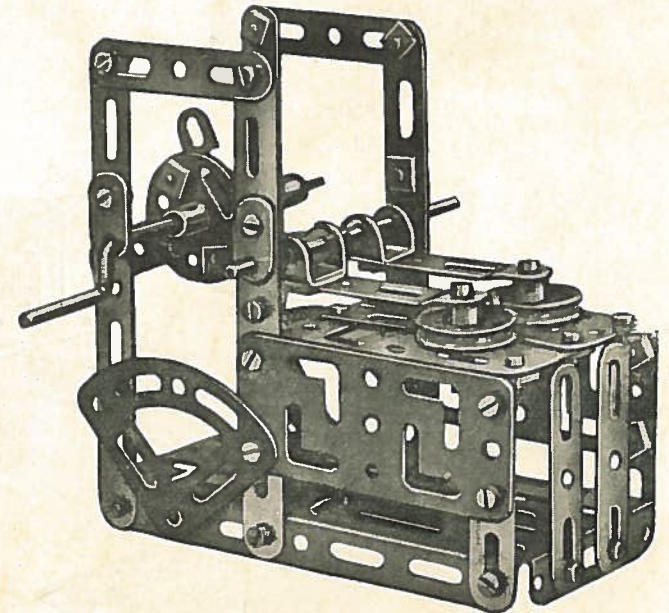

96

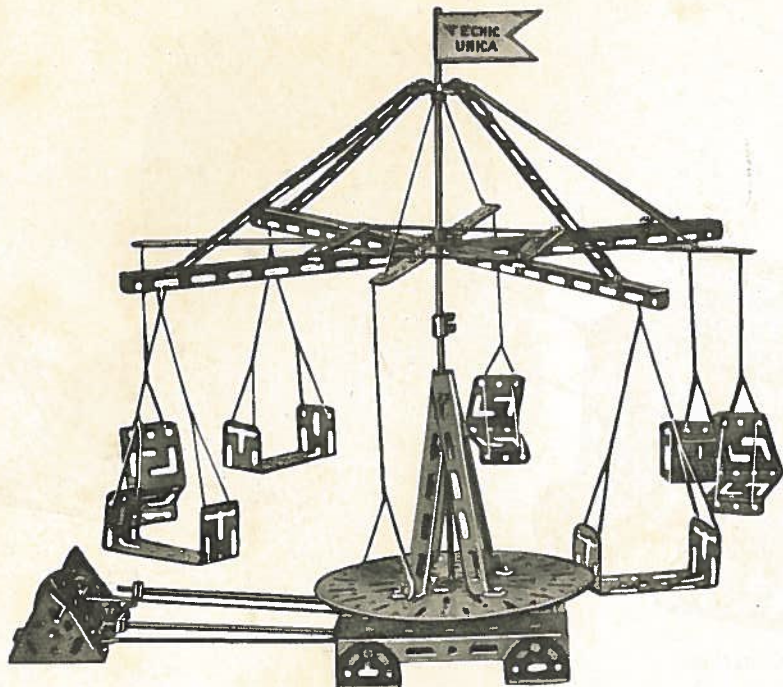

97

97. Carroussel - Slingermolen
 Tilting - Caballitos (Carrousel)

Pièces employées - Gebruikte stukken

2	N° 1	2	N° 13	4	N° 26
4	3	1	16	2	27F
1	4	2	16F	2	28
4	5	1	18	6	30
4	5C2	4	19	60	31
4	6	4	21	4	32
4	7	1	23	6	33
4	9	2	24	2	35
4	12	4	25	1	63

98. Ascenseur de Mine - Mijnlift
 Mine-Lift - Ascensor para mina

Pièces employées - Gebruikte stukken

2	N° 1	1	N° 16	4	N° 30
4	2	2	16F	60	31
3	3	1	18	6	32
2	4	4	19	5	33
3	5	4	21	2	34
4	6	4	25	2	40
4	7	4	26	2	44
4	9	2	27	2	45
4	12	2	27F	1	63
2	13	4	29		

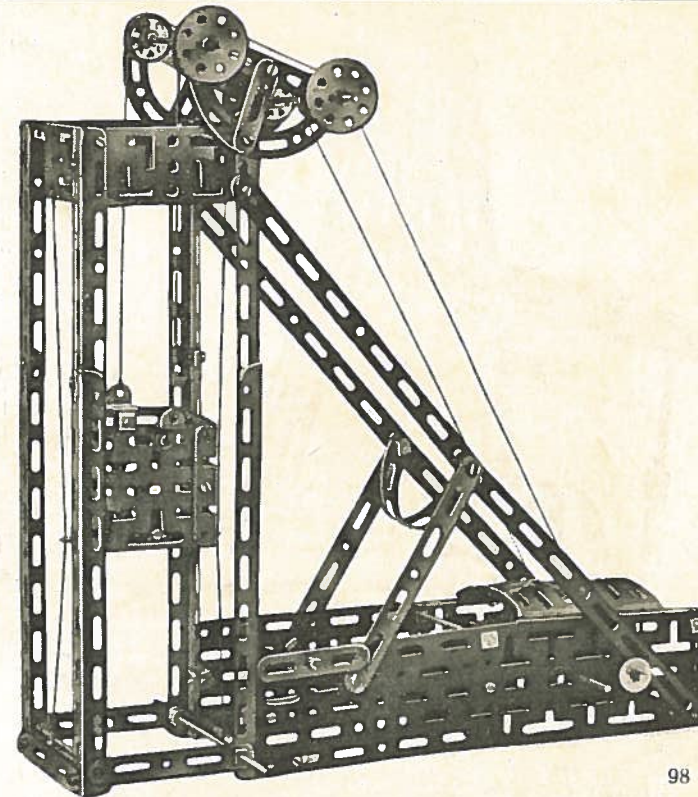

98

99. Grue mobile - Mobiele kraan
 Mobil-Crane - Grúa movil

Pièces employées - Gebruikte stukken

2	N° 1	2	N° 15	2	N° 27F
4	2	2	15F	2	28
4	3	1	16	6	29
8	4	2	16F	6	30
4	5	1	18	62	31
4	5C2	3	19	6	32
2	7	4	20	6	33
2	8	4	21	2	34
2	9	1	23	2	35
2	11	4	24	2	40
12	12	2	25	2	45
2	13	4	26	1	63

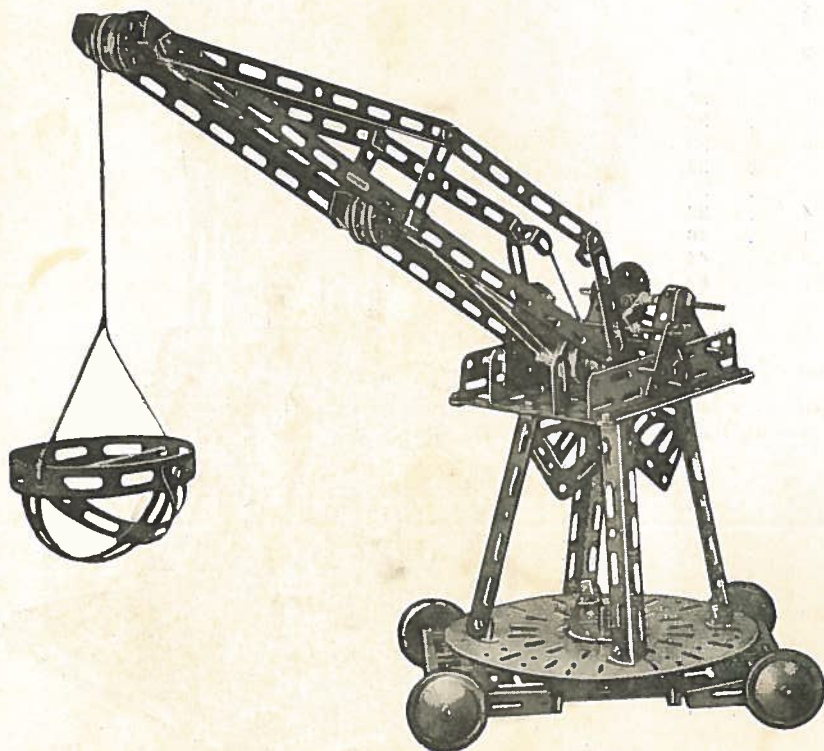

99

100. Porte-Avions - Vliegtuigmoederschip
 Airplane - Carrier Portaavions

Pièces employées - Gebruikte stukken

2	N° 1	3	N° 10	4	N° 26
2	2	2	11	60	31
4	3	2	12	4	32
8	4	3	13	2	33
4	4C	2	15F	2	34
4	5	1	16F	1	38
4	5C2	4	19	2	40
4	6	4	21	4	32PI
4	7	2	22	2	44
2	8	2	24	2	45
2	9	4	25		

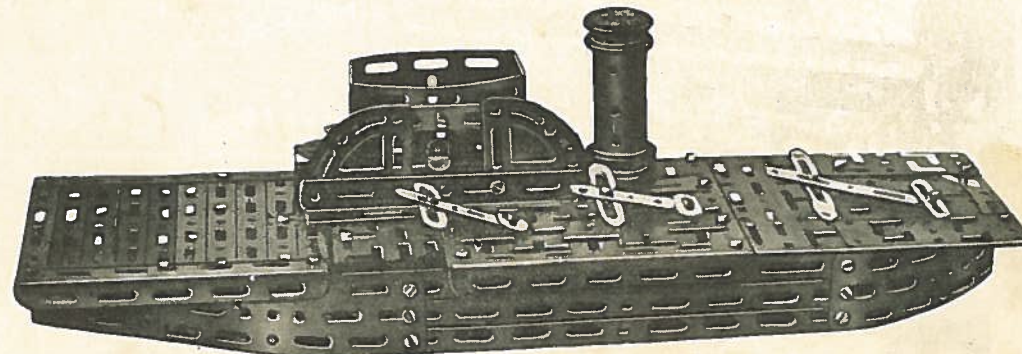

100

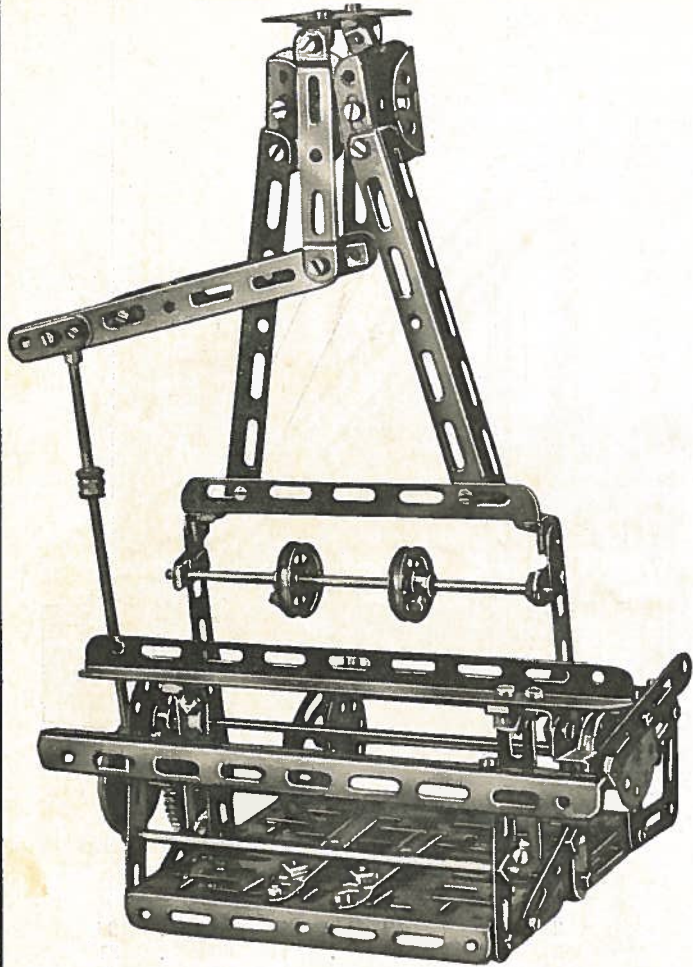

101. Métier Jacquard - Weefgetouw
Loom - Telar Jacquard

Pièces employées — Gebruikte stukken

N° 1		N° 19	
2	2	4	1
2	3	1	20
4	4	4	21
8	4	2	26
2	4C	1	27
3	5	2	27F
4	8	1	28
4	9	1	28F
2	10	2	29
3	11	60	31
12	12	3	32
1	13	1	34
1	15F	4	39
1	16F	2	40

102. Batteuse à Lin

Boommachien met motor - Flax-Beater
Trilladora de linho

Pièces employées — Gebruikte stukken

N° 1		N° 23	
2	3	1	24
3	4	2	25
4	4	3	27F
4	5	2	28
2	5C2	2	29
2	6	6	30
2	7	6	31
1	8	60	32
2	9	6	33
4	11	6	34
10	12	2	35
2	15	2	38
2	15F	1	39
1	16	1	40
1	16F	2	43
3	19	2	63
4	20	1	
4	21		

101

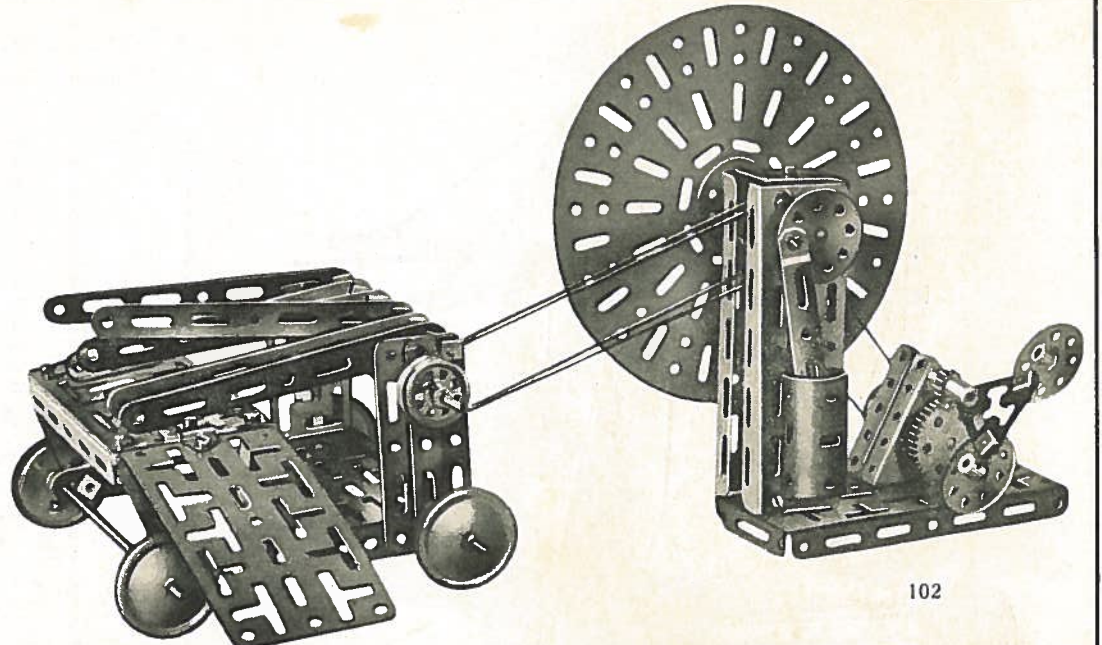

102

103. Ponceuse - Vrijmachien

Polish-Machine - Apomazadora

Pièces employées — Gebruikte stukken

N° 1		N° 21	
2	4	4	22
8	4	2	26
2	4C	4	27
4	5	2	28
1	8	2	30
4	9	6	31
2	10	60	32
6	11	6	33
12	12	6	34
4	13	2	35
1	15	2	39
2	15F	4	40
2	16	1	44
1	16F	2	63
1	18	1	
1	19		

104. Machine à percer - Boormachien

Bore Machine - Maquina para taladrar

Pièces employées — Gebruikte stukken

N° 1		N° 19	
2	2	3	24
2	3	2	26
4	4	2	27
1	4	2	27F
4	4C	2	29
4	5C2	6	30
2	6	6	31
2	8	50	32
3	9	6	33
1	13	6	35
2	15F	2	63
1	16	1	
1	18		

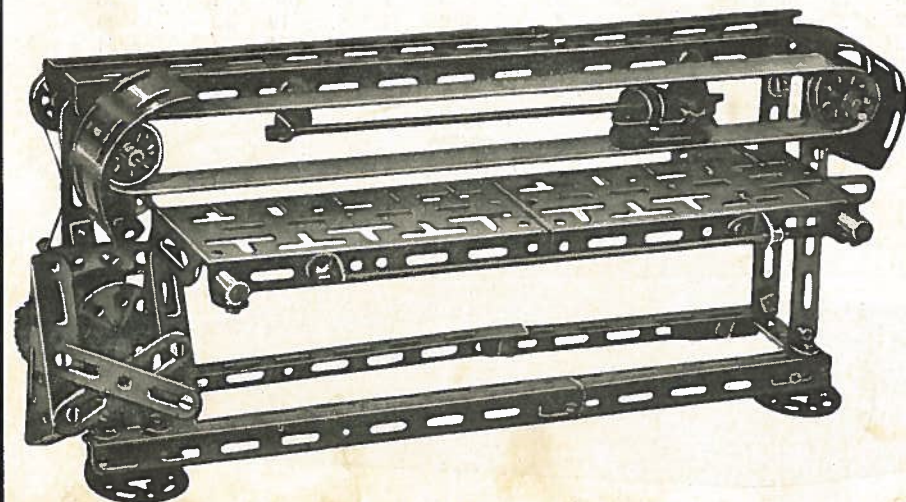

103

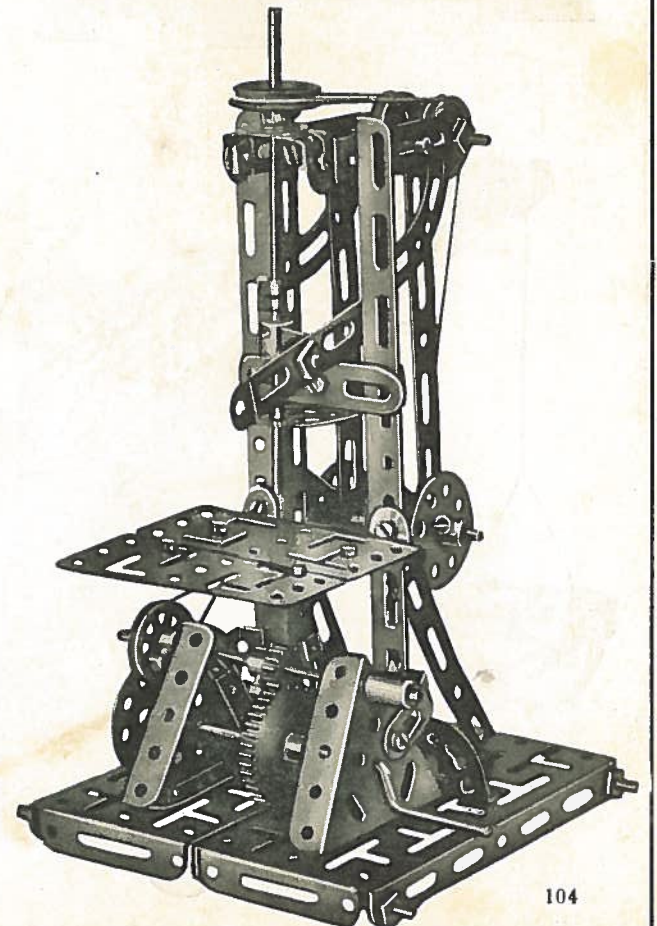

104

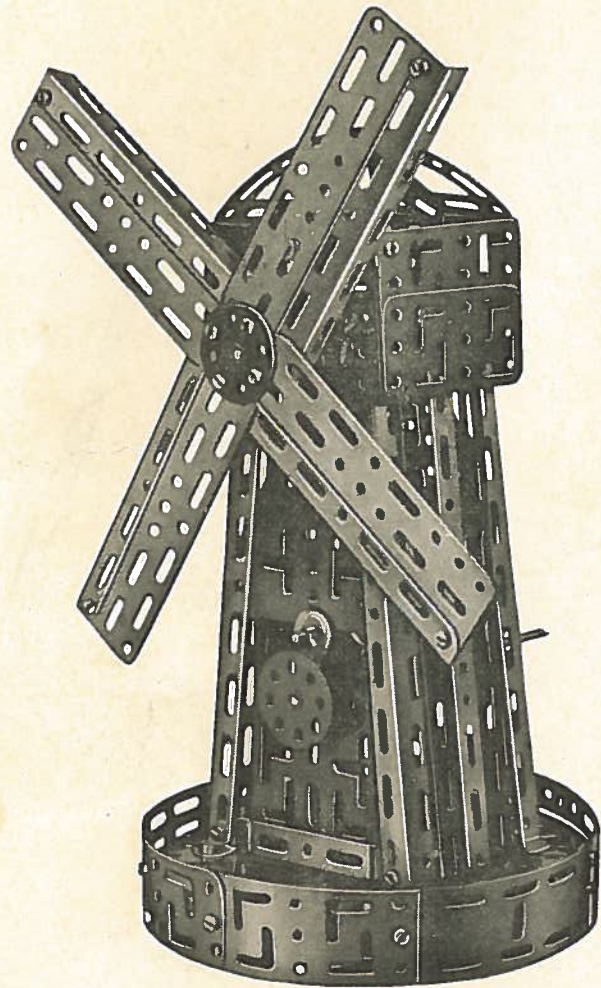

105

105. Moulin à vent - Windmolen
Wind-Mill - Molino de viento

Pièces employées - Gebruikte stukken

2	N° 1	8	12	2	29
4	2	1	16	6	30
3	3	2	16F	60	31
6	4	1	18	3	32
4	4C	4	19	6	33
4	5	4	21	2	34
2	5C2	1	23	2	35
4	6	2	24	2	40
4	7	4	25	2	44
4	9	4	26	2	45
4	10	1	27	1	63

106. Yacht - Yate

Pièces employées - Gebruikte stukken

2	N° 1	4	19
4	2	2	22
3	3	2	24
1	4	4	25
4	4C	3	26
4	5	1	27F
3	5C2	1	28
4	6	1	29
4	7	55	31
4	9	5	33
1	11	2	34
8	12	2	40
1	15F	2	44
1	16F	2	45

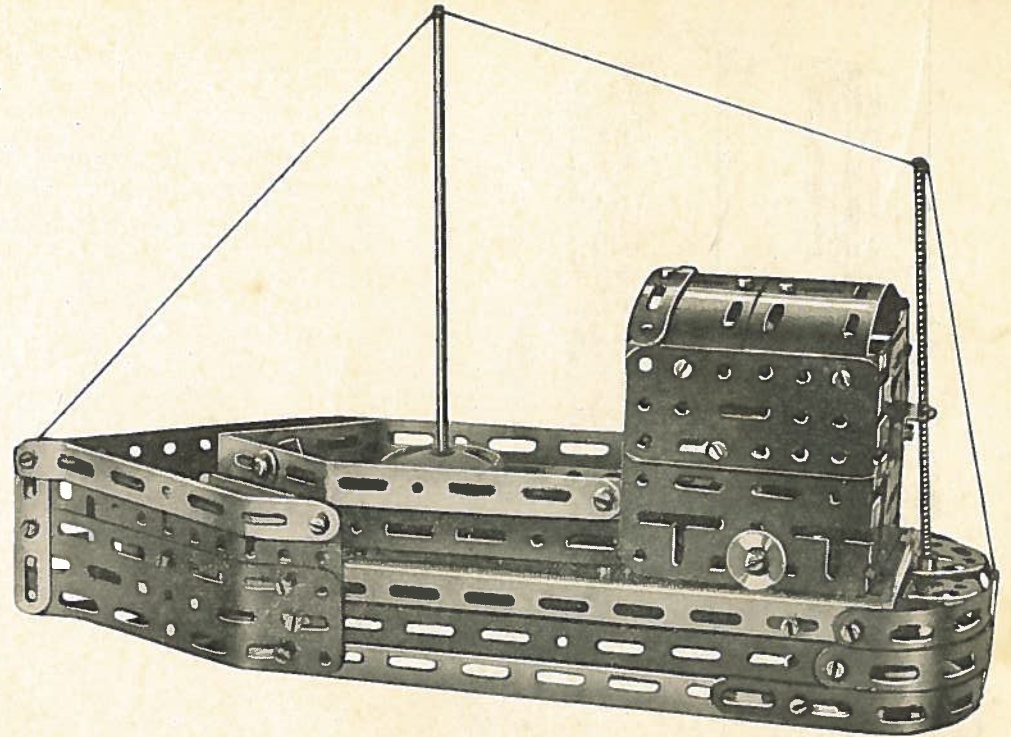

106

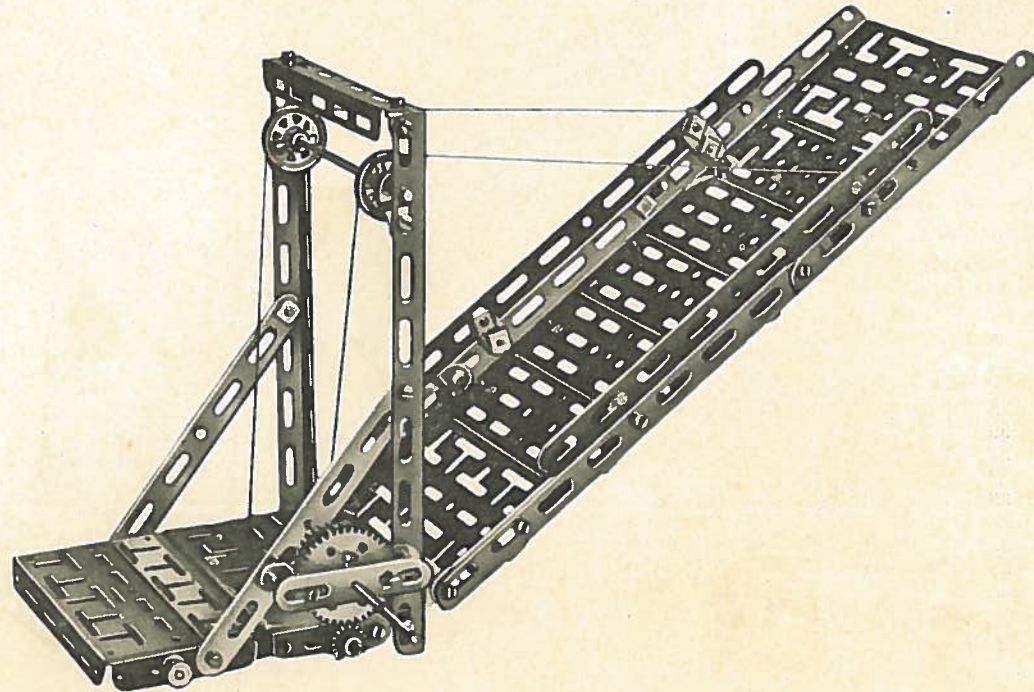

107

107. Pont Lévis - Ophaalbrug
Draw Bridge - Puente levadizo

Pièces employées - Gebruikte stukken

2	N° 1	2	25
2	3	4	26
1	4	1	27
4	5	1	27F
2	6	1	28
4	7	4	30
1	9	60	31
2	10	2	32
6	11	2	33
4	12	2	34
4	13	2	35
1	18	2	45
3	21	1	63

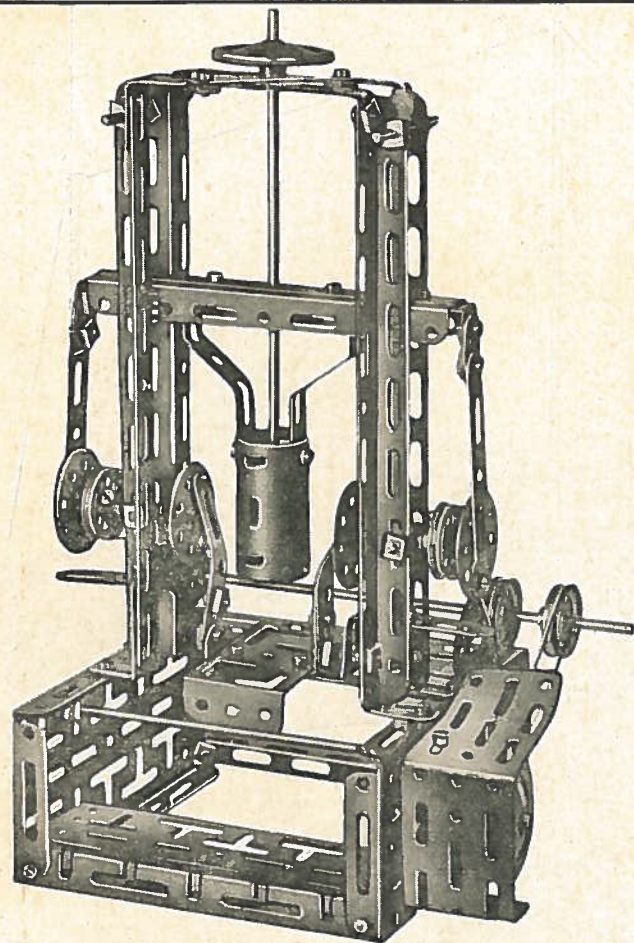

108

108. Presse automatique - Automatische pres
Automatic-Press - Prensa automatica

Pièces employées - Gebruikte stukken

2 . . . N° 1	2 . . . 20
2 . . . 3	4 . . . 21
7 . . . 4	1 . . . 25
4 . . . 4C	4 . . . 26
4 . . . 5C2	1 . . . 27F
2 . . . 6	2 . . . 28
1 . . . 7	6 . . . 30
2 . . . 9	60 . . . 31
4 . . . 11	6 . . . 32
5 . . . 12	6 . . . 33
2 . . . 13	2 . . . 34
2 . . . 15	2 . . . 35
2 . . . 15F	1 . . . 38
1 . . . 16	2 . . . 45
4 . . . 19	

110. Grue sur chenilles - Kraan op rupsen
Crane on chenill - Grúa sobre carterpillars

Pièces employées - Gebruikte stukken

2 . . . N° 1	4 . . . 20
4 . . . 2	4 . . . 21
2 . . . 3	1 . . . 23
8 . . . 4	2 . . . 24
4 . . . 4C	2 . . . 25
4 . . . 5	4 . . . 26
4 . . . 5C2	2 . . . 27
4 . . . 6	2 . . . 27F
4 . . . 7	3 . . . 29
4 . . . 8	6 . . . 30
2 . . . 9	60 . . . 31
2 . . . 11	6 . . . 32
4 . . . 12	6 . . . 33
4 . . . 13	2 . . . 34
1 . . . 15	2 . . . 35
2 . . . 15F	2 . . . 40
1 . . . 16	2 . . . 44
2 . . . 16F	2 . . . 45
1 . . . 18	1 . . . 63
4 . . . 19	

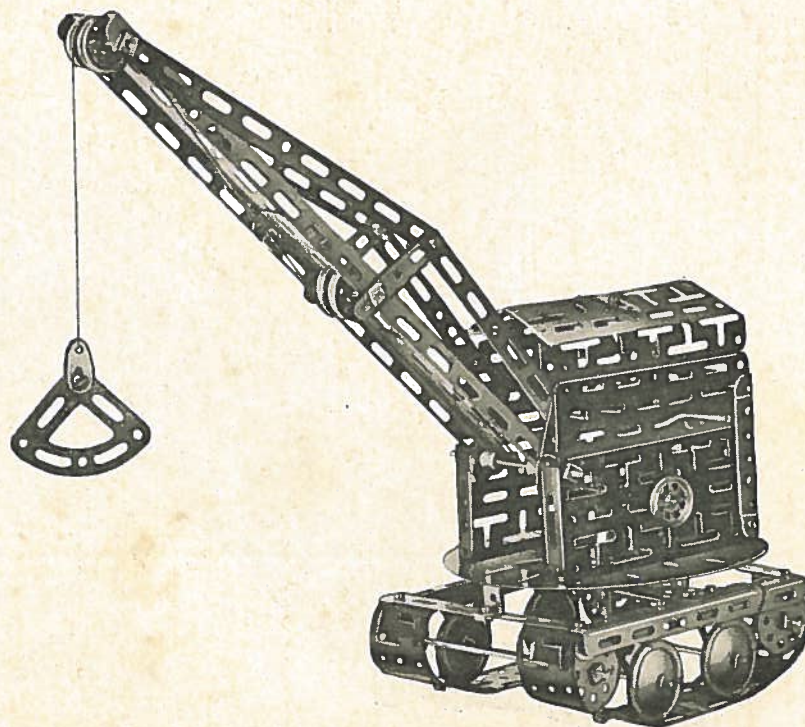

110

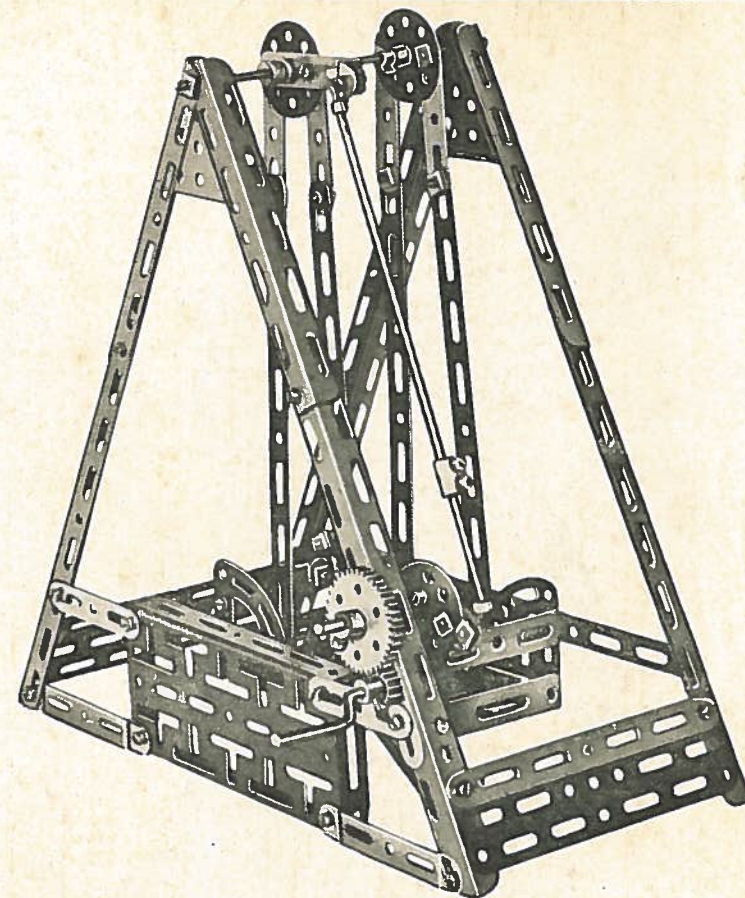

109

109. Balançoire automatique - Schommel
Swing - Columpio

Pièces employées - Gebruikte stukken

2 . . . N° 1	1 . . . 22
4 . . . 2	2 . . . 24
8 . . . 4	4 . . . 25
3 . . . 4C	4 . . . 26
4 . . . 5	2 . . . 27F
4 . . . 7	4 . . . 29
2 . . . 11	6 . . . 30
4 . . . 12	54 . . . 31
1 . . . 13	2 . . . 33
1 . . . 15	2 . . . 34
1 . . . 15F	2 . . . 35
1 . . . 18	2 . . . 40
3 . . . 19	1 . . . 63
4 . . . 21	

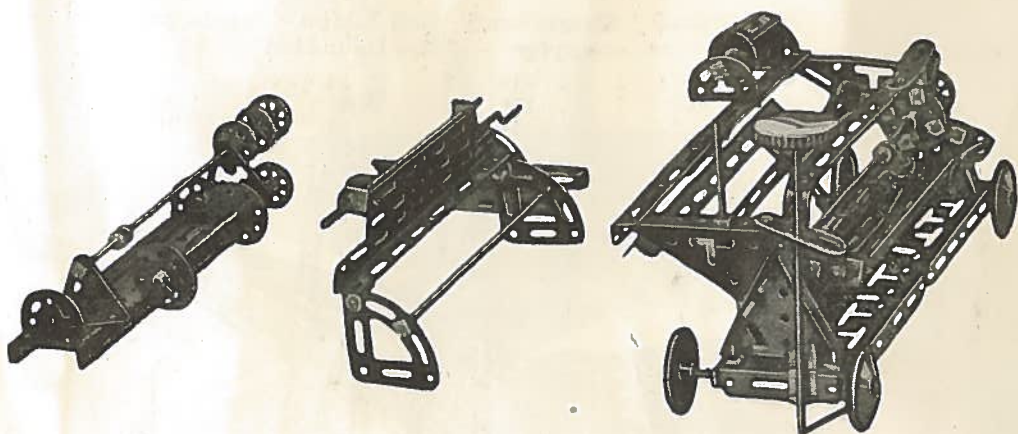

111

111. Bobinoir et accessoires — Bobinoir met benodigdheden
 Spoolmachine — Devanadera y accesorios
 pièces employées — gebruikte stukken

2 . . .	N° 1	4 . . .	11	4 . . .	20	1 . . .	27F	4 . . .	33
2 . . .	2	14 . . .	12	4 . . .	21	2 . . .	28	3 . . .	34
8 . . .	4	4 . . .	13	2 . . .	22	2 . . .	28F	1 . . .	38
4 . . .	4C	3 . . .	15F	2 . . .	24	2 . . .	29	2 . . .	39
3 . . .	7	2 . . .	16F	4 . . .	25	4 . . .	30	1 . . .	63
2 . . .	8	1 . . .	18	4 . . .	26	72 . . .	31		
4 . . .	9	4 . . .	19	1 . . .	27	6 . . .	32		

112. Pelle automatique — Automatise schup
 Automatic Shovel — Pala automatica
 Pièces employées — Gebruikte stukken

4 . . .	N° 1	1 . . .	10	3 . . .	16F	2 . . .	24	72 . . .	31	4 . . .	45
4 . . .	2	1 . . .	11	2 . . .	18	2 . . .	25	8 . . .	32	2 . . .	46
4 . . .	4	7 . . .	12	2 . . .	19	6 . . .	26	6 . . .	33	1 . . .	63
4 . . .	5	2 . . .	13	4 . . .	20	2 . . .	27	3 . . .	34		
2 . . .	5C2	2 . . .	15	4 . . .	21	3 . . .	27F	3 . . .	35		
6 . . .	6	3 . . .	15F	2 . . .	22	6 . . .	29	4 . . .	40		
8 . . .	7	1 . . .	16	2 . . .	23	8 . . .	30	1 . . .	43		

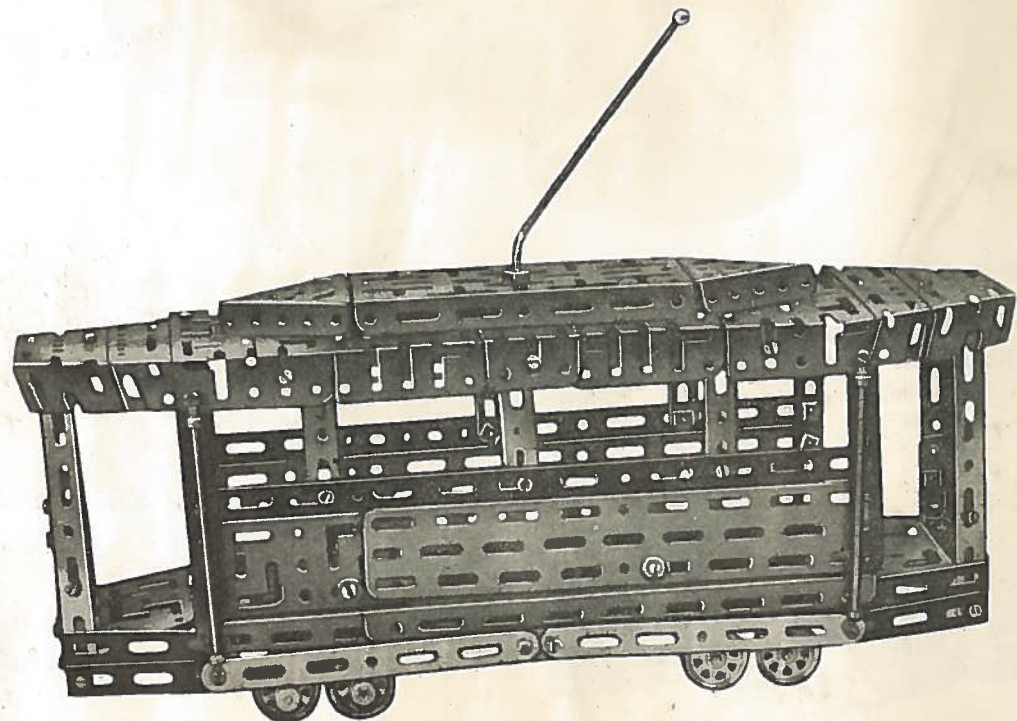

113

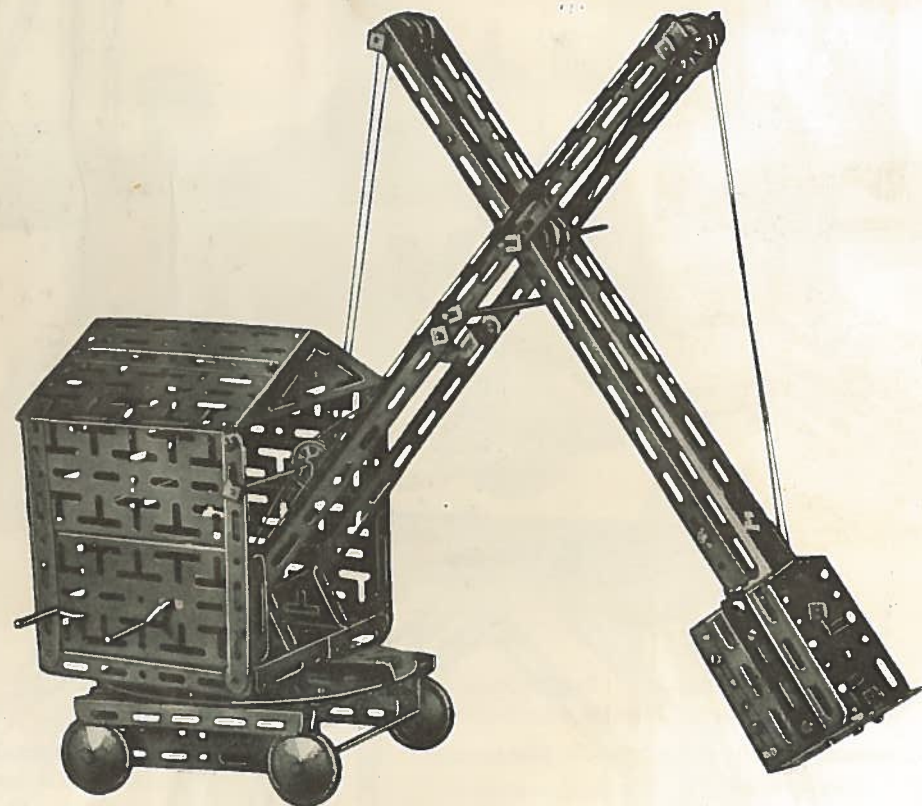

112

113. Tram électrique — Electriche tram
 Electric Streetcar — Tramvia electrica
 Pièces employées — Gebruikte stukken

3 . . .	N° 1	2 . . .	5C2	8 . . .	12	6 . . .	26	4 . . .	33
2 . . .	3	6 . . .	6	3 . . .	16	1 . . .	27F	3 . . .	34
8 . . .	4	5 . . .	7	3 . . .	16F	2 . . .	29	2 . . .	35
3 . . .	4C	4 . . .	8	4 . . .	21	4 . . .	30	4 . . .	40
8 . . .	5	6 . . .	10	2 . . .	24	80 . . .	31	2 . . .	43
4 . . .	5C	8 . . .	11	6 . . .	25	8 . . .	32	4 . . .	45

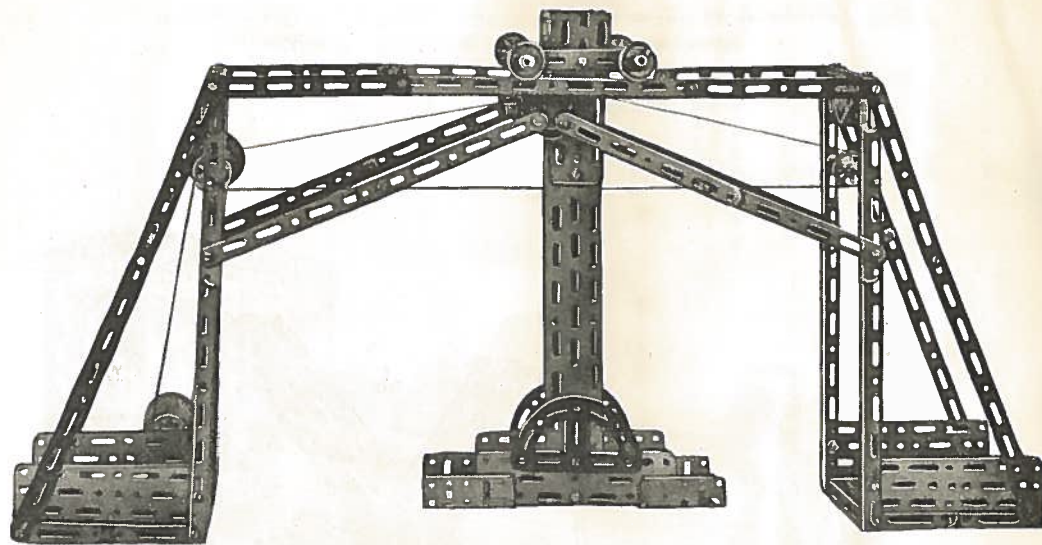

114

114. Pont roulant - Overzebrug - Roll Bridge - Puente grua

Pièces employées		Gebruikte stukken			
4 . . . N° 1	4 . . . 5C	1 . . . 16	2 . . . 24	4 . . . 29	3 . . . 35
4 . . . 2	4 . . . 5C2	1 . . . 16F	4 . . . 25	8 . . . 30	4 . . . 40
6 . . . 3	4 . . . 6	1 . . . 18	6 . . . 26	72 . . . 31	2 . . . 43
2 . . . 4	8 . . . 7	2 . . . 19	1 . . . 27	8 . . . 32	4 . . . 45
4 . . . 4C	2 . . . 9	1 . . . 20	2 . . . 27F	6 . . . 33	2 . . . 46
8 . . . 5	1 . . . 10	4 . . . 21	1 . . . 28	3 . . . 34	1 . . . 63

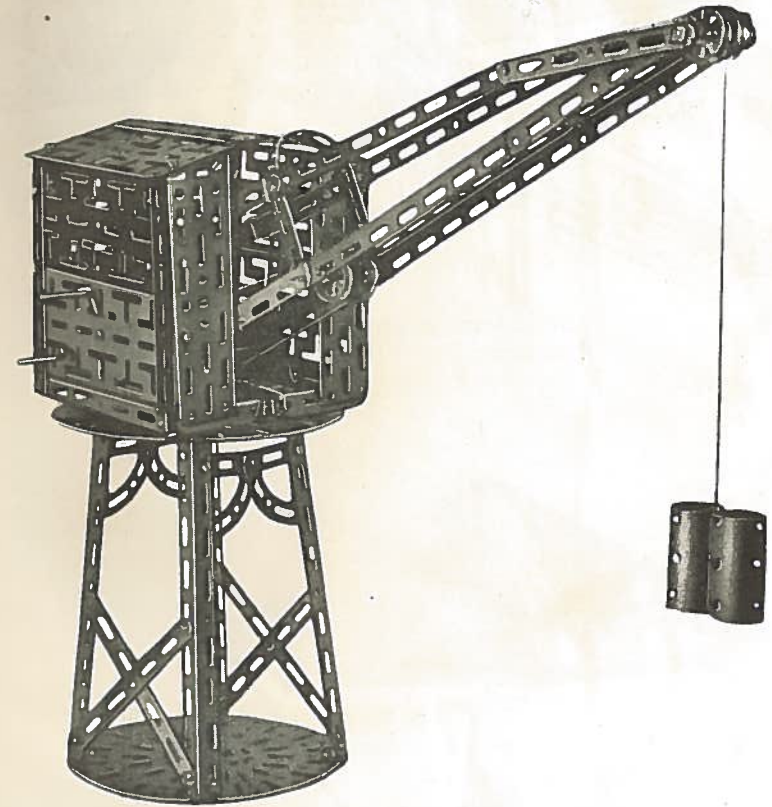

116

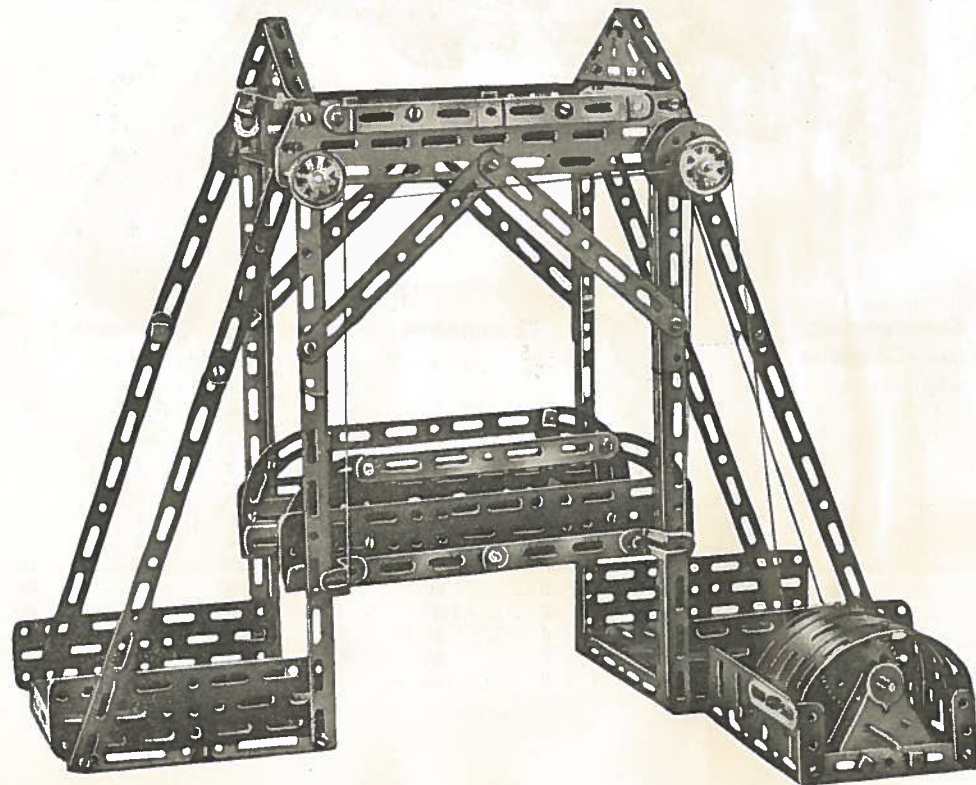

115

115. Pont automatique - Ophaalbrug
Automatic Bridge - Puente automatico

Pièces employées		Gebruikte stukken	
4 . . . N° 1	1 . . . 16F	70 . . . 31	
4 . . . 2	1 . . . 18	5 . . . 32	
5 . . . 3	1 . . . 19	5 . . . 33	
6 . . . 4	4 . . . 21	3 . . . 34	
4 . . . 4C	2 . . . 24	1 . . . 35	
7 . . . 5	6 . . . 25	4 . . . 40	
4 . . . 5C	6 . . . 26	2 . . . 43	
2 . . . 5C2	3 . . . 27F	4 . . . 45	
4 . . . 6	1 . . . 28	2 . . . 46	
8 . . . 7	4 . . . 29	1 . . . 63	
1 . . . 16	2 . . . 30		

116. Grue tournante - Draaiende kraan
Swing-Crane - Grua giratoria

Gebruikte stukken		Pièces employées	
4 . . . N° 1	2 . . . 13	2 . . . 27F	
4 . . . 2	1 . . . 15	6 . . . 29	
4 . . . 3	3 . . . 15F	8 . . . 30	
8 . . . 4	2 . . . 16	80 . . . 31	
2 . . . 4C	1 . . . 16F	6 . . . 32	
6 . . . 5	2 . . . 18	6 . . . 33	
2 . . . 5C	2 . . . 19	3 . . . 34	
1 . . . 5C2	4 . . . 21	3 . . . 35	
7 . . . 7	2 . . . 22	2 . . . 38	
2 . . . 9	2 . . . 23	4 . . . 40	
3 . . . 10	2 . . . 24	4 . . . 45	
1 . . . 11	6 . . . 25	1 . . . 63	
11 . . . 12	6 . . . 26		

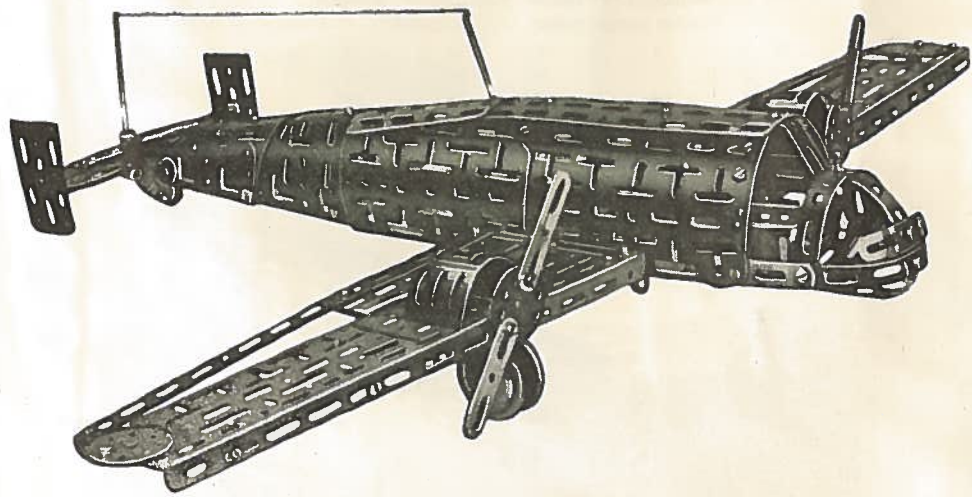

117

117. Avion de transport - Transportvliegtuig - Plane-Carrier - Avion de transporte

		Pièces employées				Gebruikte stukken					
4	N° 1	3	5C	10	12	6	21	72	31	3	40
2	2	4	5C2	2	15	6	25	6	32	2	44
3	3	6	6	3	15F	4	26	1	32PI	4	45
5	4	8	7	3	16F	1	28F	2	33		
2	4C	2	9	4	19	6	29	3	34		
6	5	2	11	4	20	8	30	2	35		

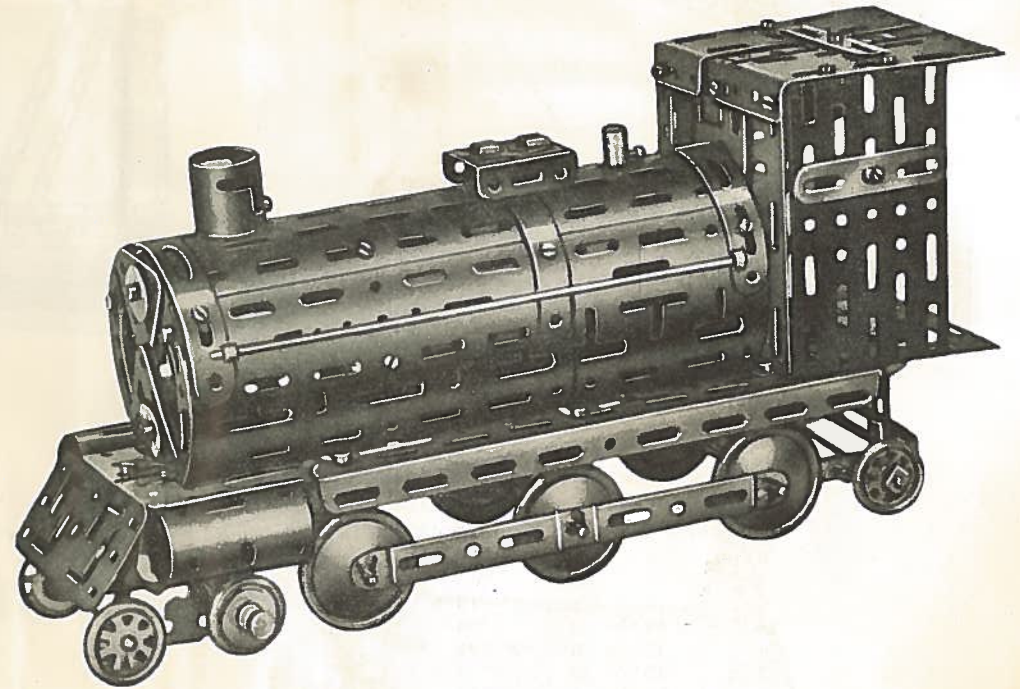

118

118. Locomotive - Locomotief - Locomotora

		Pièces employées - Gebruikte stukken			
2	N° 1	1	10	8	30
4	2	2	11	72	31
6	3	3	12	6	32
8	4	3	15F	6	33
4	4C	3	16	3	34
3	5	3	16F	1	35
4	5C	6	20	2	38
4	5C2	4	21	4	40
6	6	2	25	2	43
8	7	2	26	2	44
4	8	2	28F	4	45
3	9	6	29		

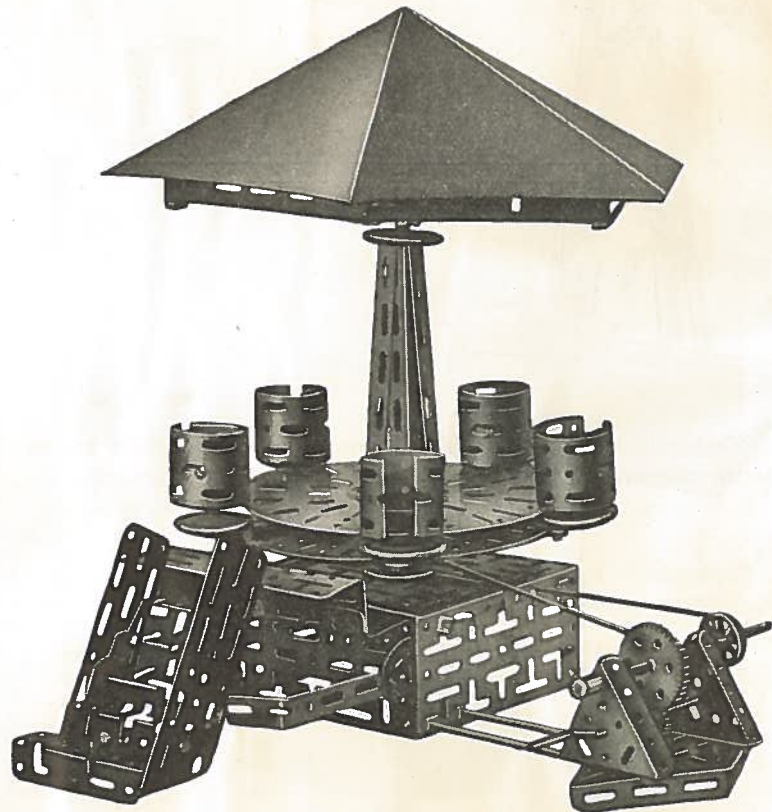

119

119. Carroussel - Kermismolen

Tiling - Caballitos «Carroussel»

Pièces employées - Gebruikte stukken

4	N° 1	2	15F	8	32
1	3	2	16F	6	33
3	4	1	18	3	34
4	4C	3	19	3	35
8	5	6	20	4	40
3	5C	4	21	5	32PI
4	5C2	2	23	2	43
2	6	2	24	2	44
8	7	1	27	4	45
2	9	4	27F	2	46
5	11	1	28	1	63
13	12	8	30		
3	15	84	31		

120. **Bateau - Boot - Ship - Buque**
 Pièces employées - Gebruikte stukken

3 . . .	N° 1	1 . . .	8	4 . . .	25	4 . . .	40
3 . . .	2	1 . . .	9	6 . . .	26	2 . . .	43
2 . . .	3	14 . . .	12	1 . . .	28F	2 . . .	44
8 . . .	4	1 . . .	15	4 . . .	30	4 . . .	45
8 . . .	5	3 . . .	15F	72 . . .	31	2 . . .	46
1 . . .	5C	4 . . .	19	2 . . .	32		
5 . . .	6	4 . . .	21	3 . . .	34		
8 . . .	7	2 . . .	22	3 . . .	35		

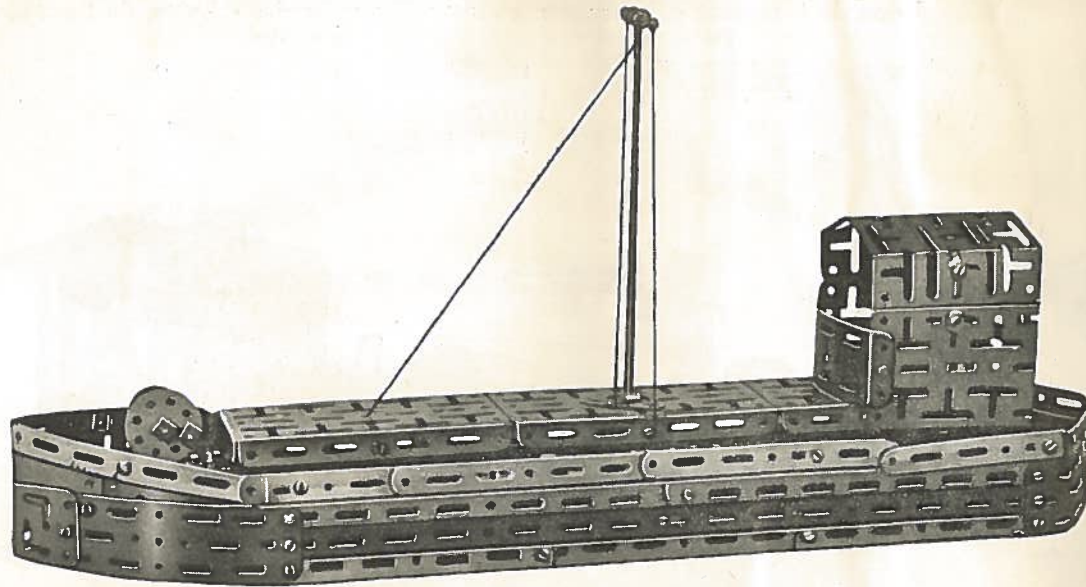

120

121. **Carroussel-avion - Vliegtuigmolen**
Plane-Tilting - Carroussel-avion
 Pièces employées - Gebruikte stukken

4 . . .	N° 1	8 . . .	7	3 . . .	16F	6 . . .	25	3 . . .	34
4 . . .	2	4 . . .	10	1 . . .	18	4 . . .	26	3 . . .	35
4 . . .	4	6 . . .	11	3 . . .	19	4 . . .	28F	4 . . .	39
1 . . .	4C	14 . . .	12	2 . . .	20	6 . . .	29	4 . . .	40
8 . . .	5	4 . . .	13	4 . . .	21	8 . . .	30	2 . . .	43
2 . . .	5C	3 . . .	15	2 . . .	22	76 . . .	31	1 . . .	63
4 . . .	5C2	3 . . .	15F	1 . . .	23	7 . . .	32		
3 . . .	6	3 . . .	16	2 . . .	24	6 . . .	33		

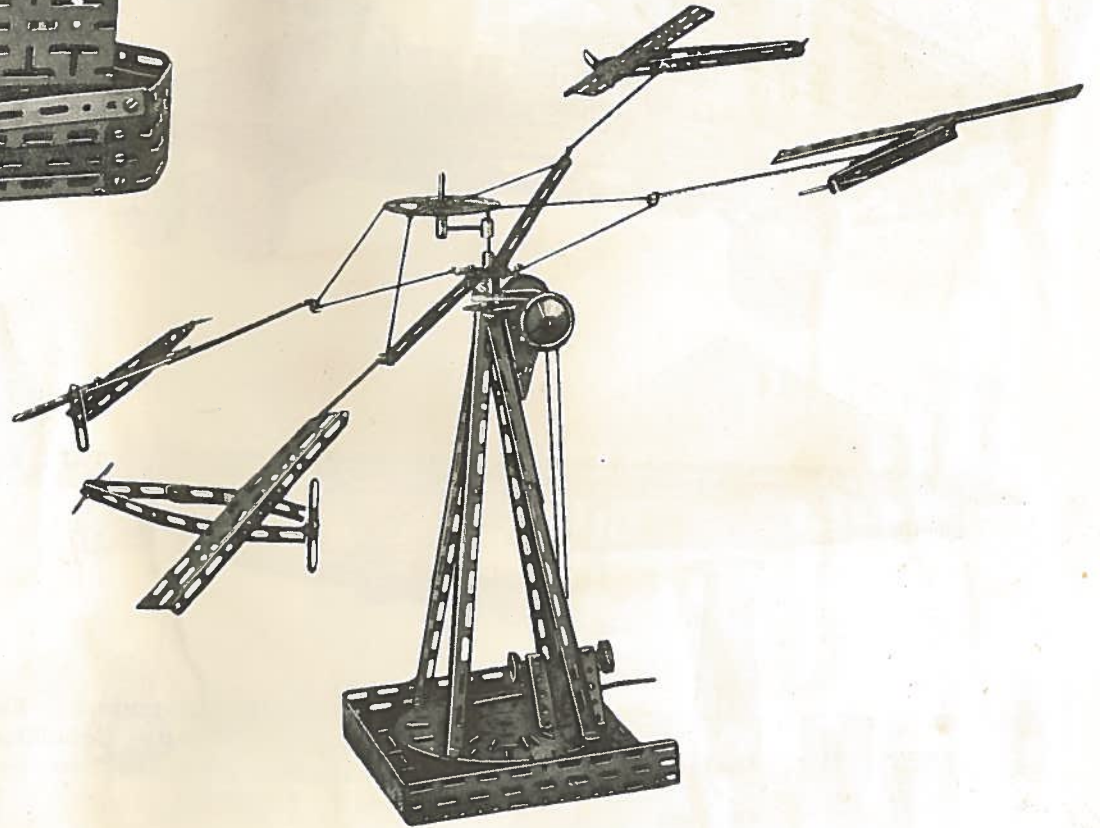

121

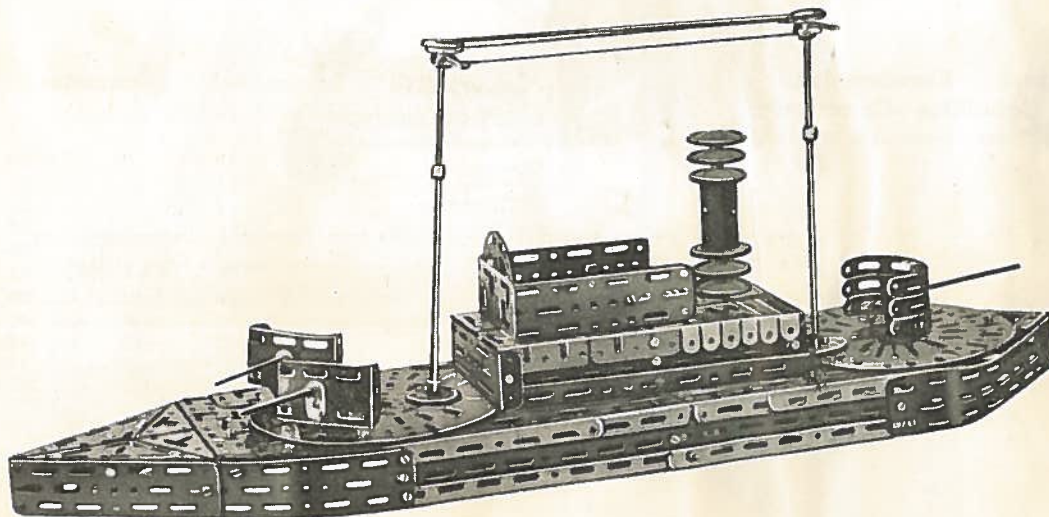

122

122. **Croiseur - Kreuzer - Cruiser - Crucero**
 Pièces employées - Gebruikte stukken

4 . . .	N° 1	6 . . .	6	3 . . .	16F	6 . . .	26	3 . . .	35
4 . . .	2	8 . . .	7	4 . . .	19	4 . . .	27F	1 . . .	38
3 . . .	3	3 . . .	9	6 . . .	20	3 . . .	29	4 . . .	40
2 . . .	4	2 . . .	10	4 . . .	21	8 . . .	30	2 . . .	43
1 . . .	4C	6 . . .	11	2 . . .	22	72 . . .	31	2 . . .	44
8 . . .	5	4 . . .	12	2 . . .	23	2 . . .	32	4 . . .	45
3 . . .	5C	3 . . .	15F	2 . . .	24	6 . . .	33	2 . . .	46
4 . . .	5C2	3 . . .	16	6 . . .	25	3 . . .	34		

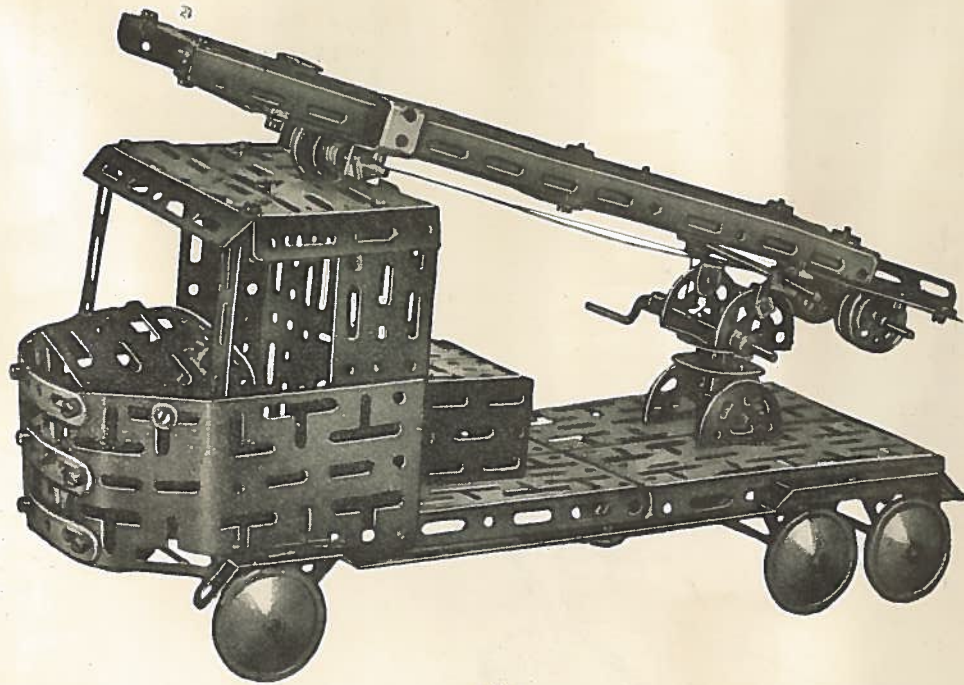

123

123. Auto de pompier - Pompierauto - Fire-Engine - Automovile para bambero

		pièces employées		—		gebruikte stukken					
4	N° 1	1	5C2	4	13	6	20	2	29	3	35
2	2	3	6	2	15F	4	21	8	30	2	40
4	3	8	7	1	16	2	24	82	31	4	45
3	4	4	8	2	16F	4	25	5	32	1	47
4	4C	4	9	2	18	4	26	2	33		
3	5C	8	12	3	19	3	27	2	34		

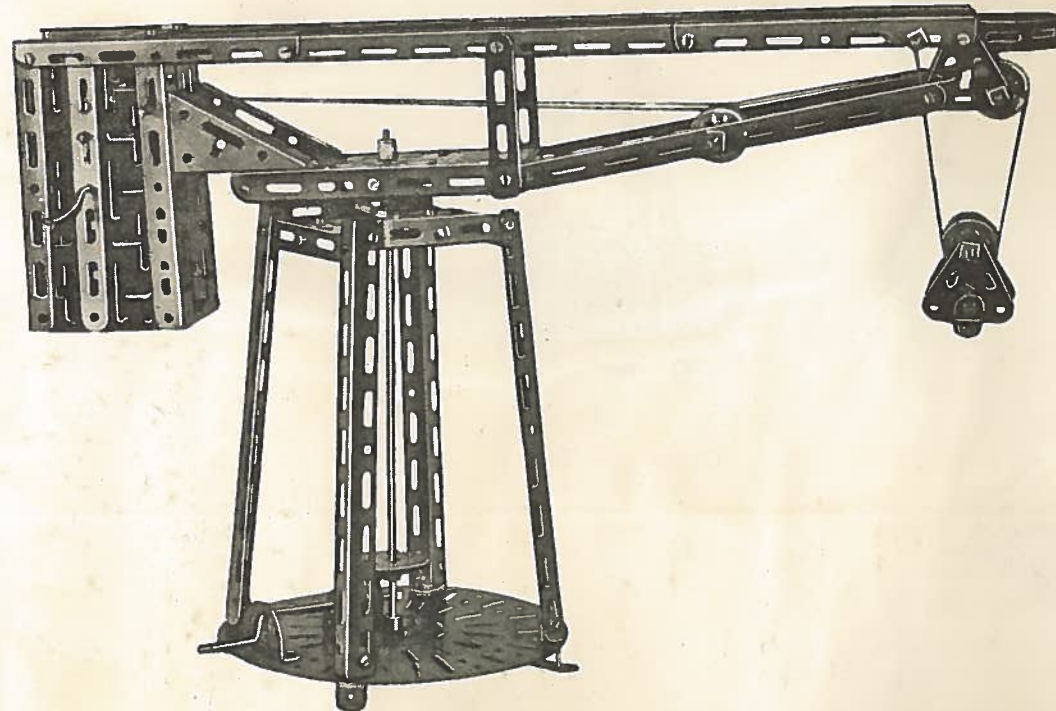

125

124. Grue roulante - Stelling kraan
Roll-Crane - Grua movil (rodante)

		pièces employées		—		gebruikte stukken					
4	N° 1	6	20	8	32	3	13	6	29		
4	3	3	21	2	33	6	15F	8	30		
4	4	2	24	2	34	2	16	72	31		
8	5	4	25	2	35	2	16F	8	32		
3	5C	6	26	4	40	2	18	6	33		
3	7	2	27	2	43	1	19	3	34		
4	9	4	27F	4	45	3	6	6	21	3	35
2	13	1	28	2	46	4	8	2	22	4	40
1	16F	6	29	1	63	4	9	1	23	2	45
2	18	8	30			5	10	2	25	1	63
3	19	80	31			6	11	6	26		
						8	12	1	28F		

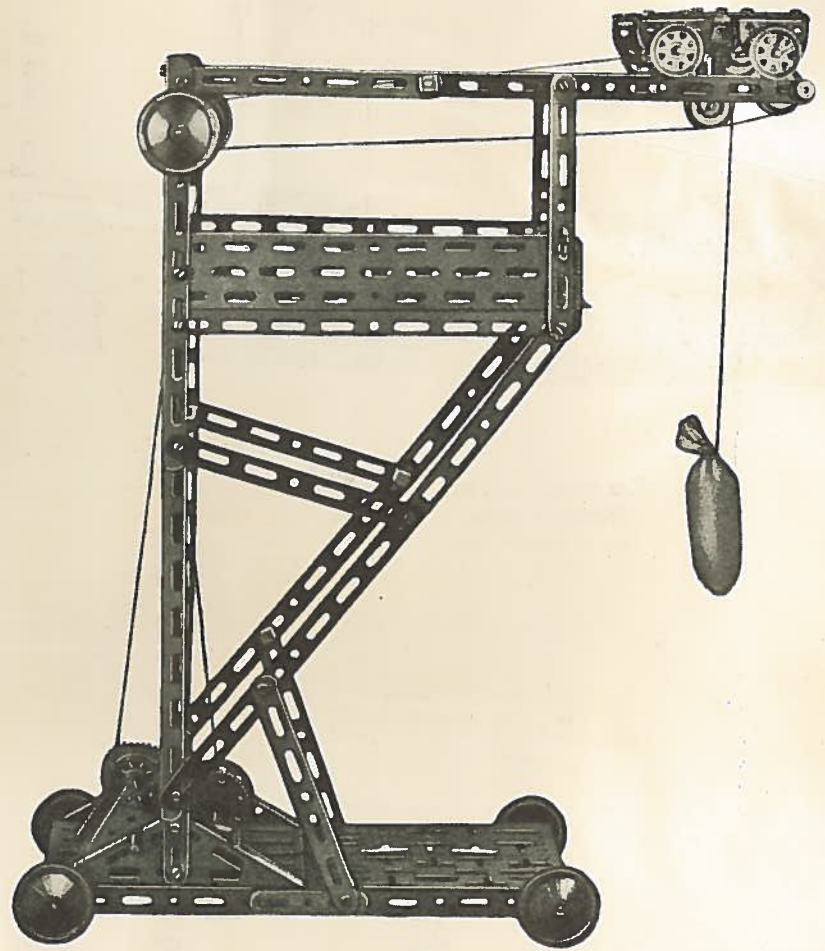

124

125. Grue tournante - Draaiende kraan
Swing-Crane - Grua giratoria

		pièces employées		—		gebruikte stukken	
3	N° 1	6	13	6	29		
6	3	12	15F	8	30		
2	4	2	16	72	31		
2	5	3	16F	8	32		
2	5C	2	18	6	33		
1	5C2	3	19	3	34		
3	6	6	21	3	35		
4	8	2	22	4	40		
4	9	1	23	2	45		
5	10	2	25	1	63		
6	11	6	26				
8	12	1	28F				

TECHNIC

