

**märklin**  
metall

**Themenkasten  
Lastkraftwagen**

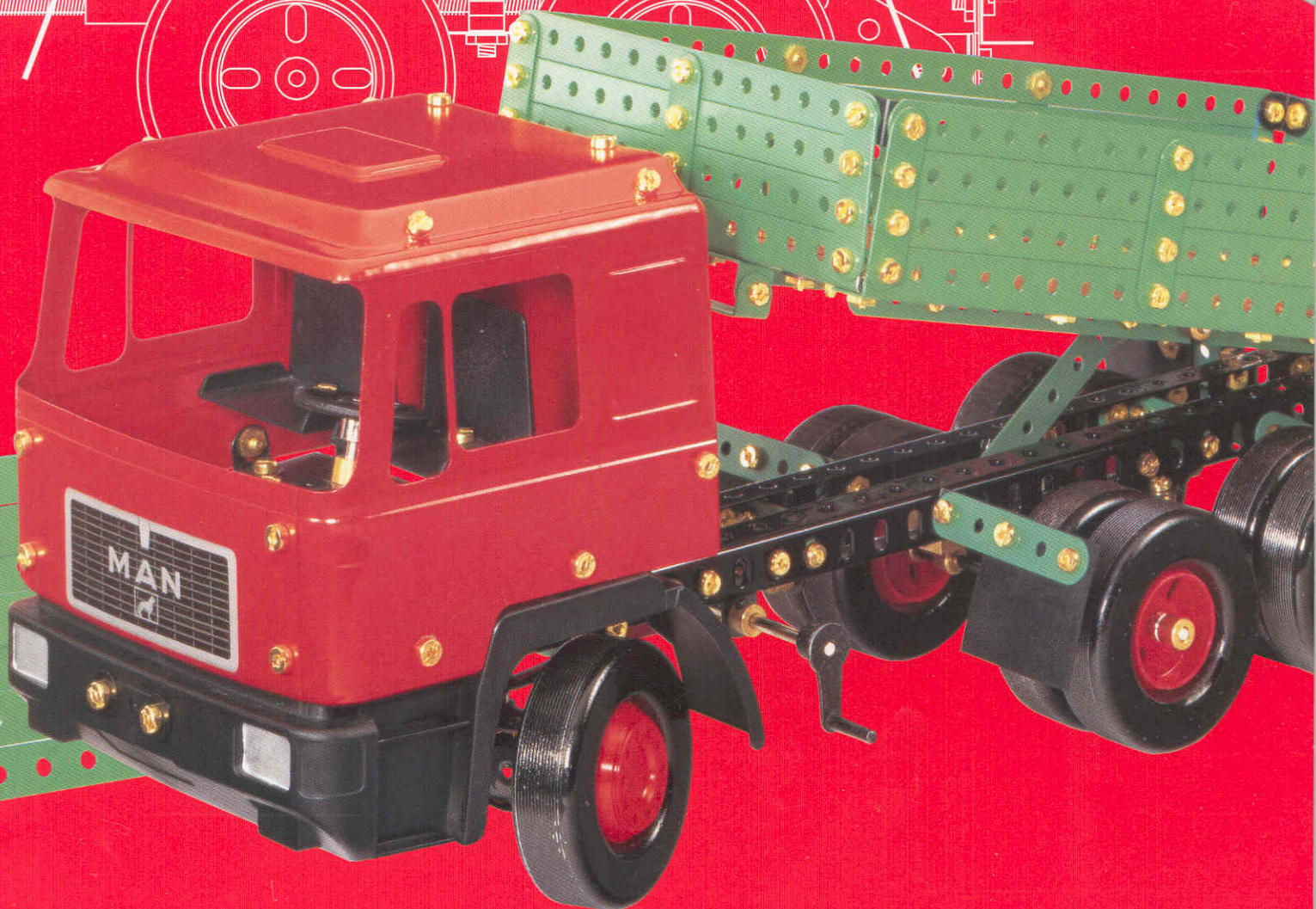

**metall**

**1085**



# Themenkasten „Lastkraftwagen“

## Theme set “Truck”

## Coffret à thème «Camions»

## Themadoos „Vrachtwagen“

### Inhalt · Contents · Sommaire · Inhoud

Seite · Page · Page · Blz.

---

Die neue Schraubtechnik The new nuts and bolts technology La nouvelle technologie du vissage De nieuwe schroeftechniek	3 – 7
Grundmodell Basic model Maquette de base Basismodel	8 – 14
Pritschenwagen Flatbed Unimog truck Camion-plateau Wagen met open laadvloer	15 – 18
Kipper Dump Truck Camion-benne Kiepwagen	19 – 24
Schneeräumer Snow plow Chasse-neige Sneeuwruimer	25 – 27
Inhalt Contents Contenu Inhoud	28 – 29

---

## Die neue Schraubtechnik

Die neue, kombinierte Innensechskant-/Schlitzschraube macht die Handhabung jetzt noch einfacher. Sie wird vom Sechskant-Schraubendreher sicher festgehalten. So läßt sich die Schraube spielend leicht und ohne herunterzufallen in die Bohrung einführen. Fest mit der Gegenmutter verschraubt sind die Bauteile stabil miteinander verbunden.

## The new nuts and bolts technology

The new bolt has a hexagonal head and a slot. It can be held with the hex head screwdriver and can be guided into the hole without falling out. When the nut is tightened, the individual parts are firmly fastened together.

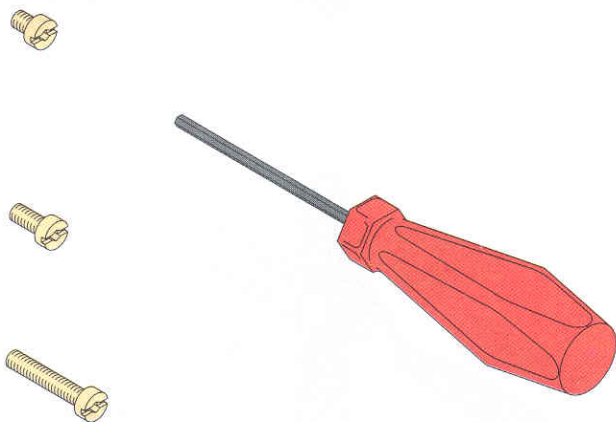

Die Märklin Bauanleitung zeigt viele Beispiele zum Nachbauen. Sie sollen jedoch hauptsächlich als Anregung für selbständiges Planen und Konstruieren dienen. Das Märklin-Metall-Baukastensystem bietet dafür nahezu unerschöpfliche Möglichkeiten.

The individual parts for each construction step should be laid out beforehand to facilitate the assembly procedure.

Our assembly instructions contain examples of models that can be built with these sets. They are intended as a guide for you to plan and build your own models using the inexhaustible possibilities of the Märklin Metall construction sets.

## La nouvelle technologie du vissage

La nouvelle vis comprend une tête avec intérieur hexagonal. On la maintient à l'aide d'une clé à six pans et sans qu'elle ne tombe. Facile à introduire, fixée par l'écrou, les pièces sont assemblées solidement.

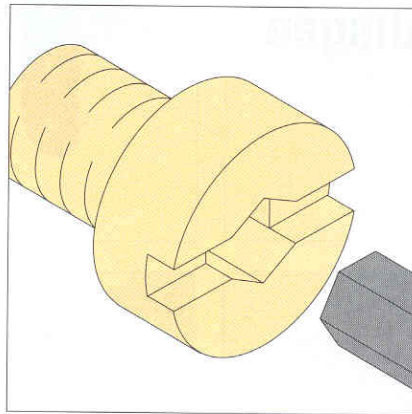

## De nieuwe schroeftechniek

De nieuwe schroef bezit een kop met een binnenzeskant en gleuf. Hij wordt met de zeskant-

schroefvedraaier vastgehouden en zonder dat hij vallen kan met opvallend gemak in het schroefgat geleid. Als de aparte onderdelen met de moer vastgeschroefd zijn, zijn ze onderling zeer stevig verbonden.



Nous conseillons de préparer les pièces nécessaires pour la construction d'un modèle. Le montage est alors plus facile.

Notre manuel d'instructions comporte un certain nombre de modèles à construire. Il incite à la conception individuelle de modèles et à leur réalisation par les innombrables possibilités qu'offrent les boîtes de construction métal de Märklin.

De aparte onderdelen moeten bij iedere bouw-fase voor het monteren overzichtelijk klaar gelegd worden. Er kan dan gemakkelijker gewerkt worden.

Onze bouwbeschrijving geeft voorbeelden voor nabouw. Hij moet inspireren voor het zelfstandig plannen en construeren met de onuitputtelijke mogelijkheden van de Märklin-metaalbouwdoos.

**Feste Schraubverbindungen**  
**Rigid bolt connections**  
**Assemblage-vis rigide**  
**Vaste schroefverbindingen**

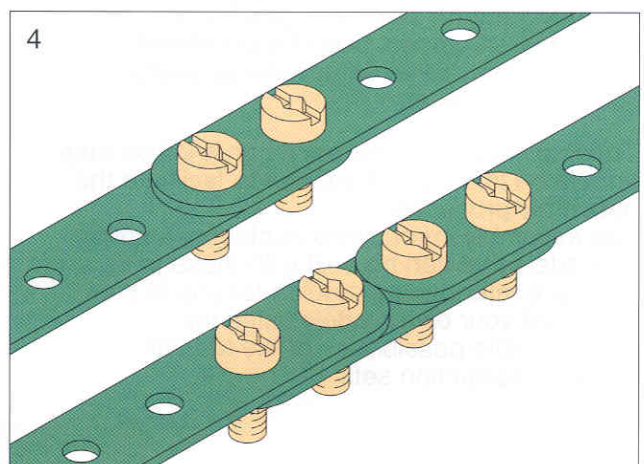
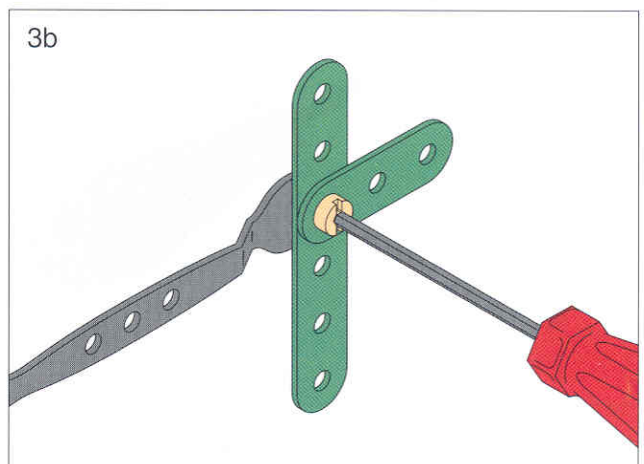
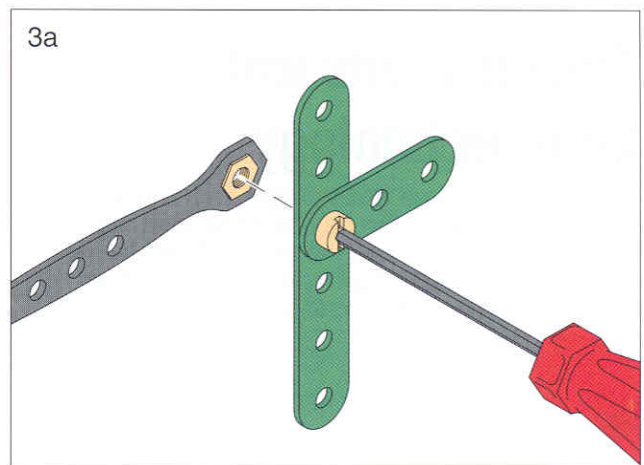
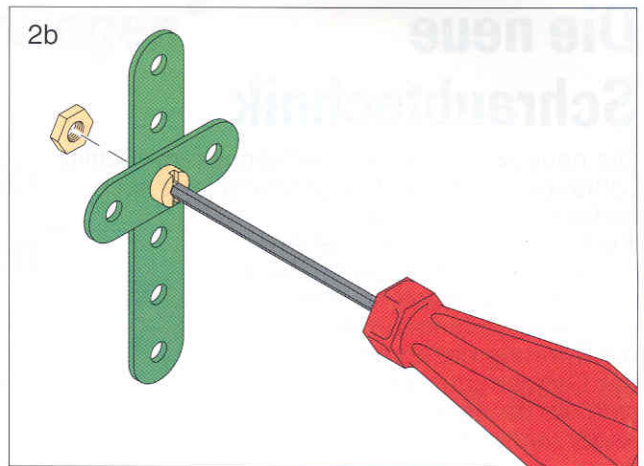
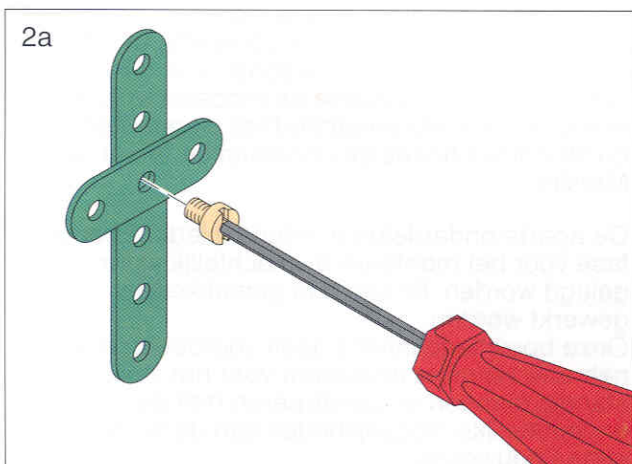
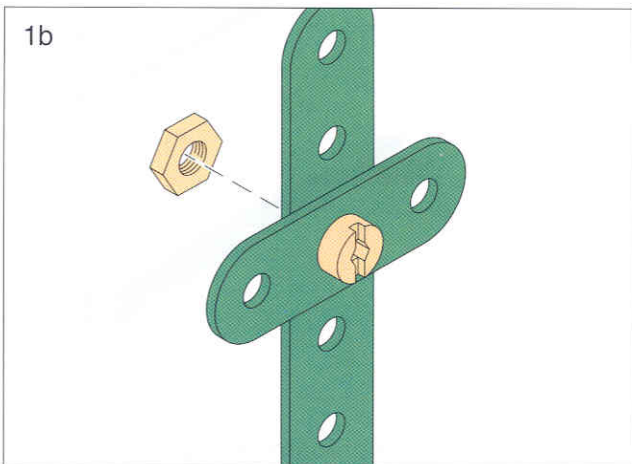
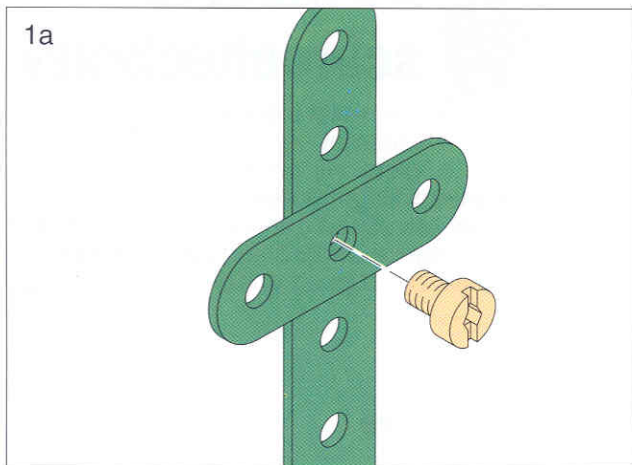



**Bewegliche Verbindungen**  
**Flexible joints**  
**Assemblage-vis flexible**  
**Beweglijke verbindingen**

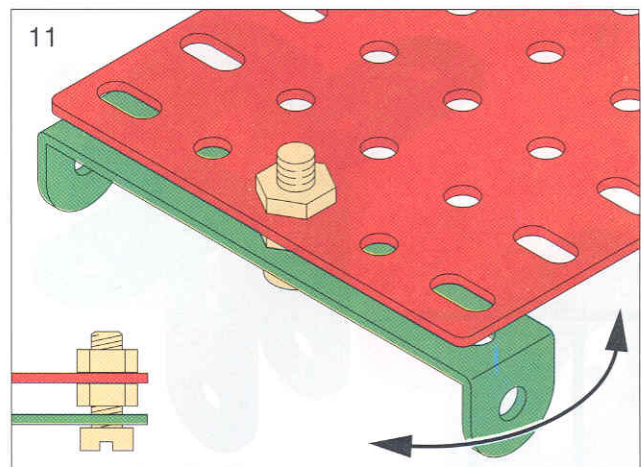
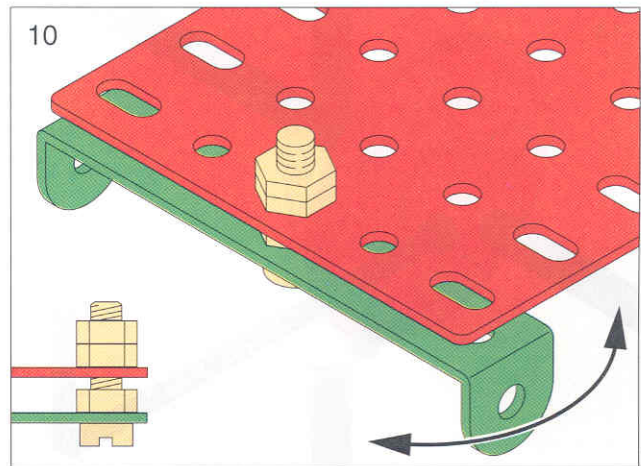
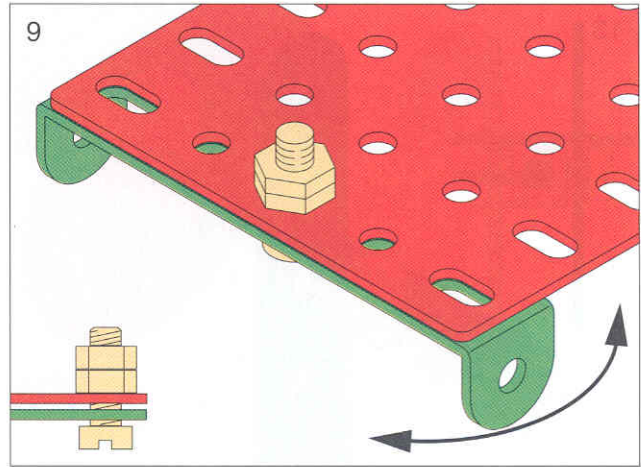
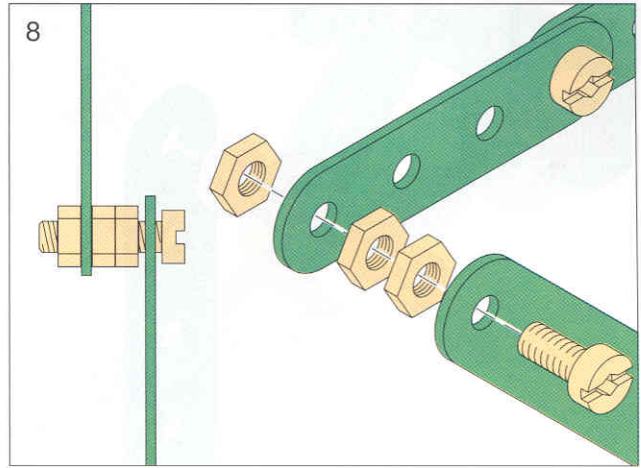
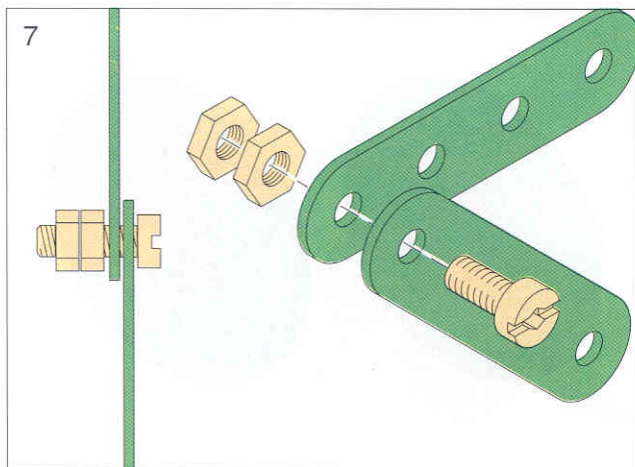
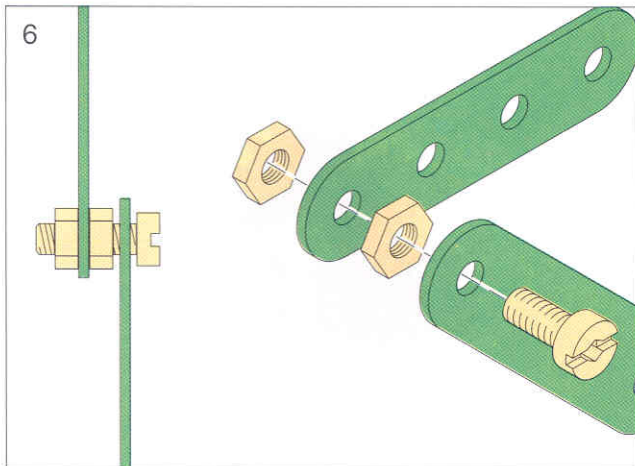
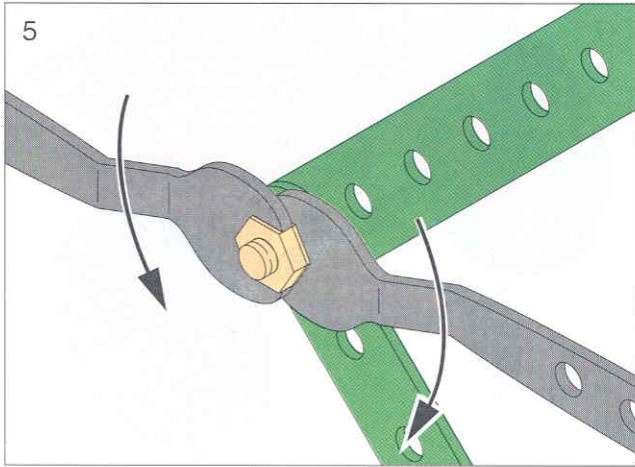

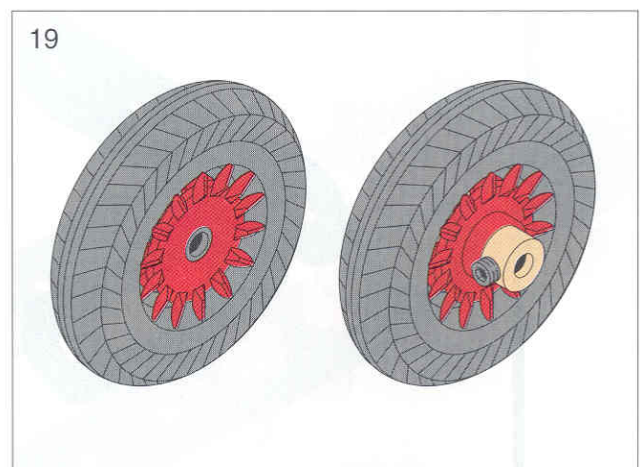
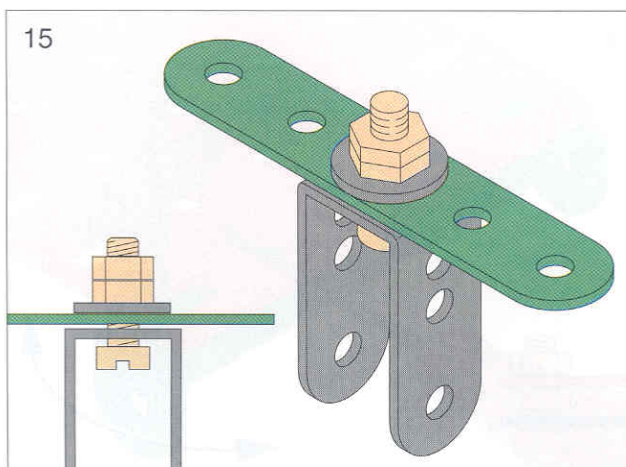
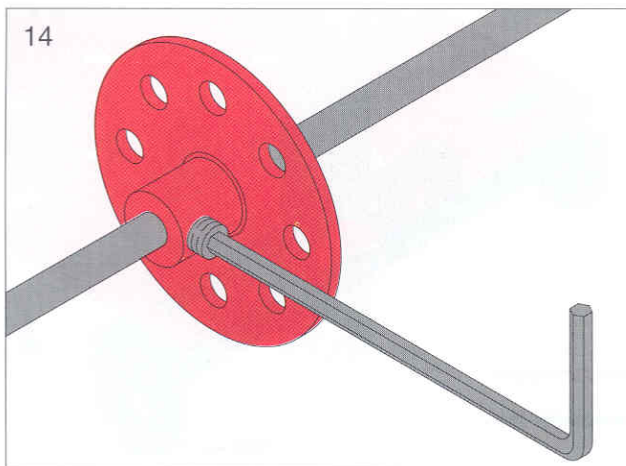
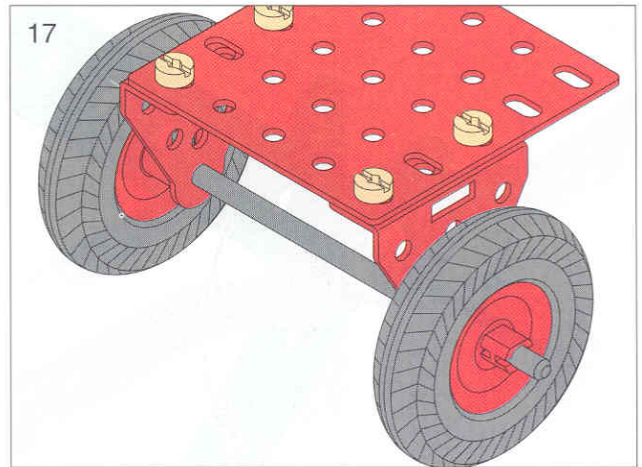
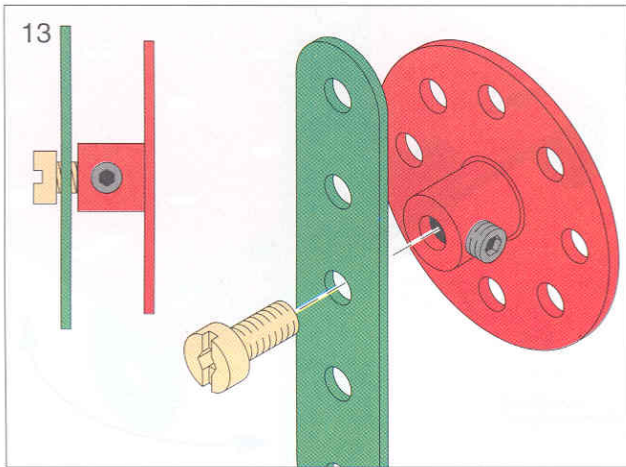
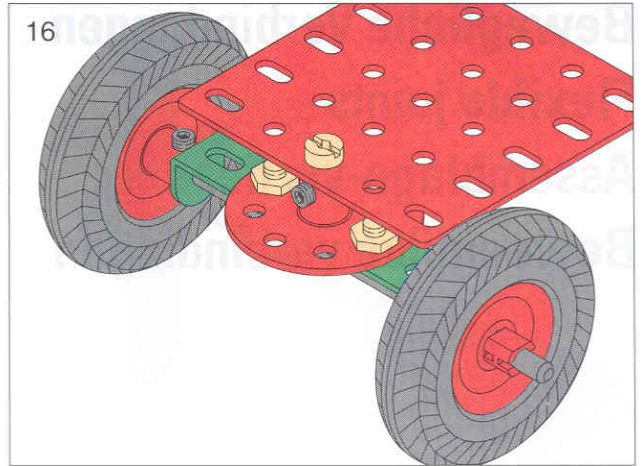
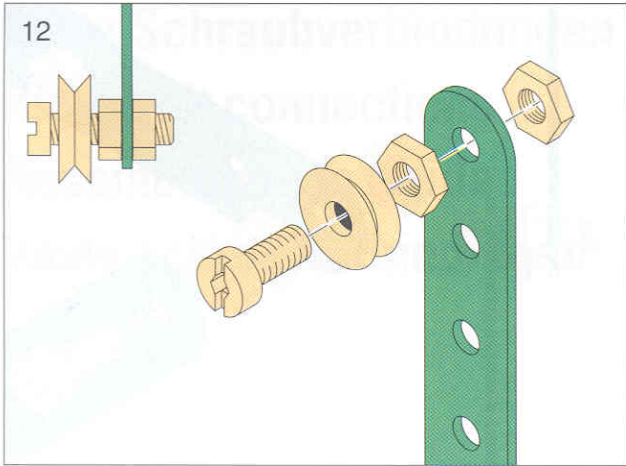



20

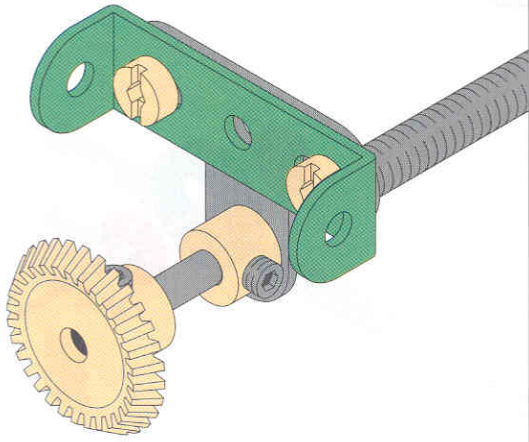

24

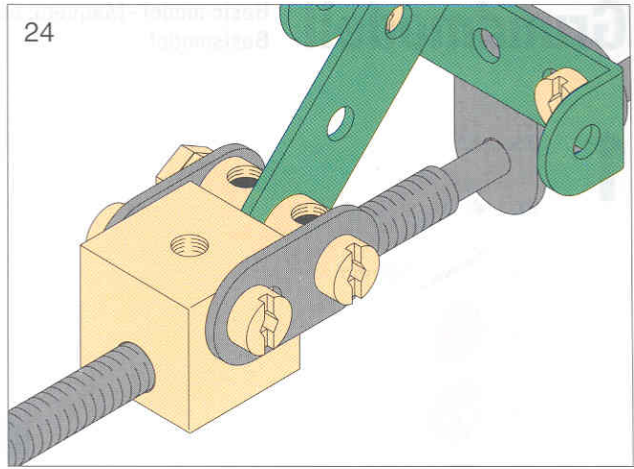

21

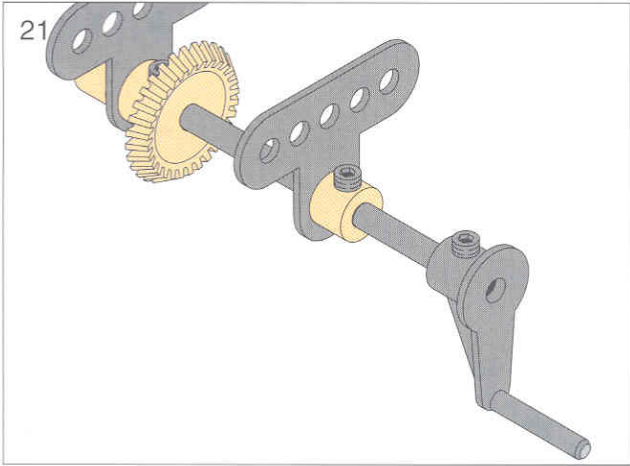

25

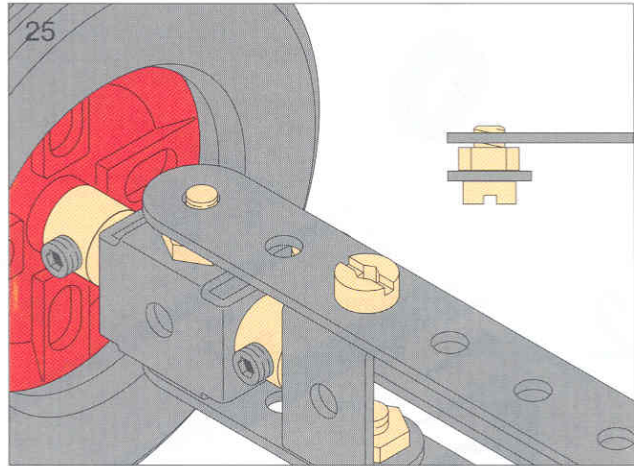

22



26

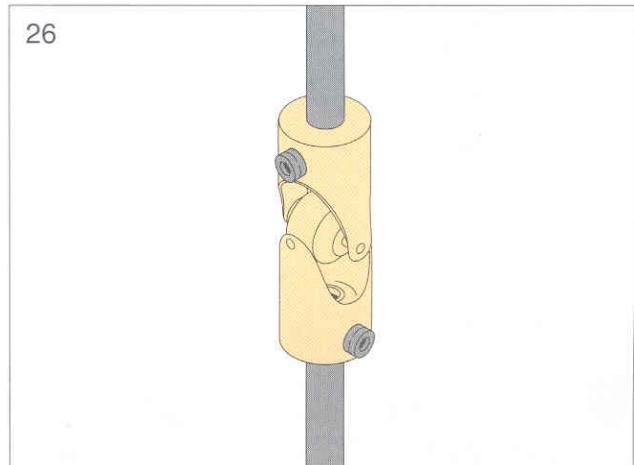

23

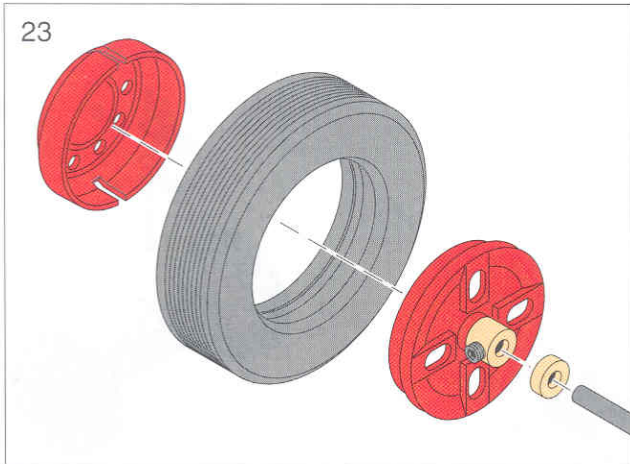

27

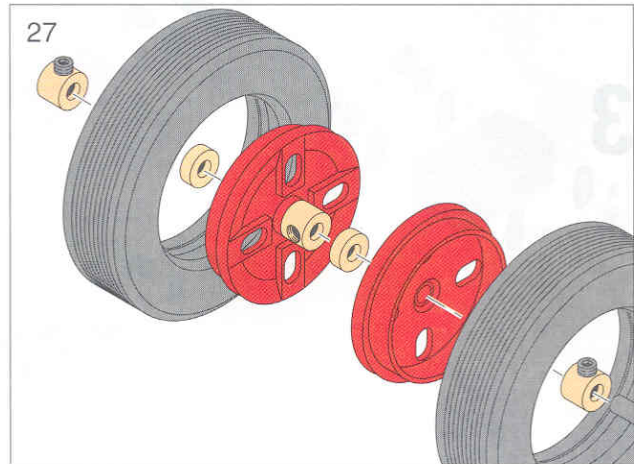

# Grundmodell







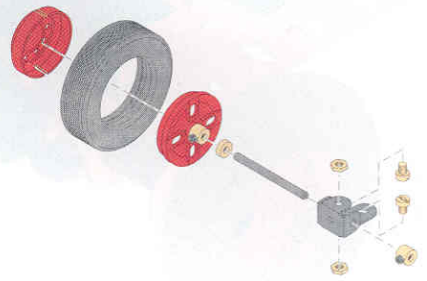



Basic model · Maquette de base  
Basismodel

## 1

- 2 x 
- 2x 
- 2 x  50 mm
- 2 x 
- 2 x 
- 2 x 
- 2 x 



## 2

- 1 x  30 mm
- 1 x  50 mm
- 1 x  60 mm
- 3 x 
- 1 x 
- 2 x 
- 1 x 
- 2 x 
- 2 x 
- 2 x 
- 2 x 

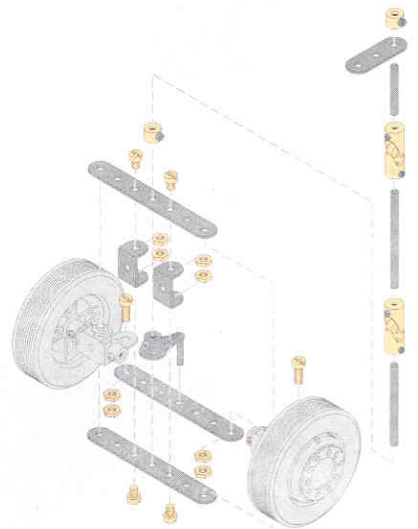

## 3





# 4

- 2 x
- 3 x
- 4 x
- 4 x
- 2 x
- 6 x
- 18 x
- 2 x

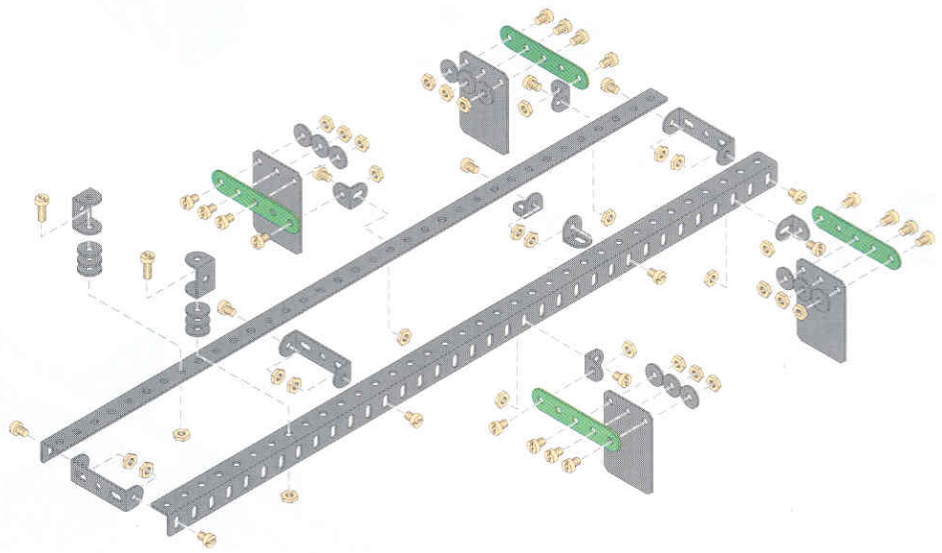





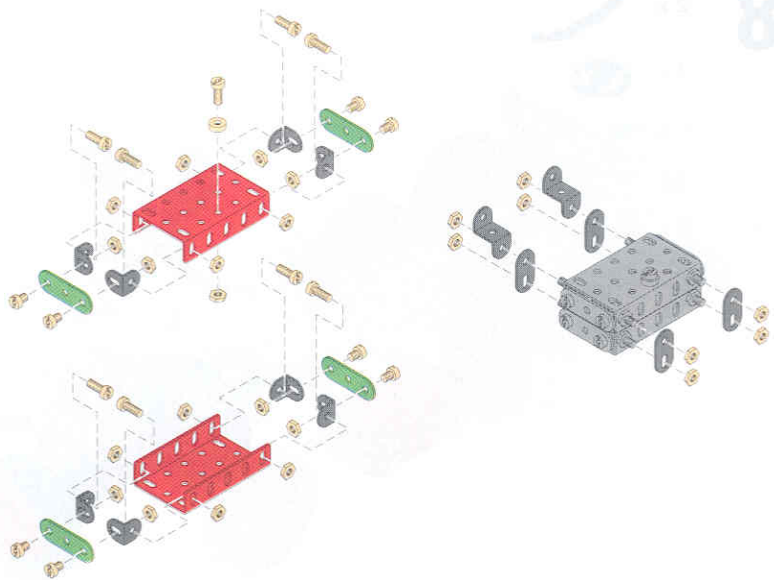

# 5

- 4 x
- 2 x
- 4 x
- 8 x
- 2 x
- 1 x
- 9 x



6

- 2 x 
- 2 x 
- 1 x 
- 3 x 
- 2 x 
- 1 x 

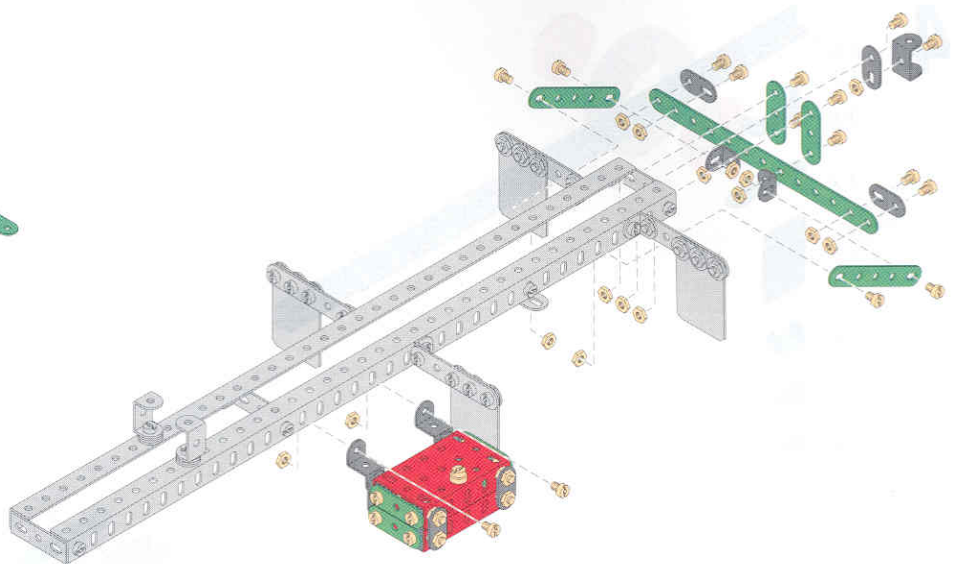

7

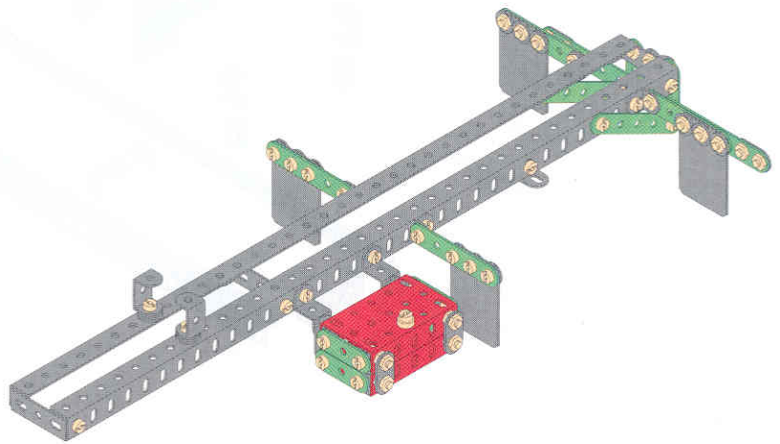





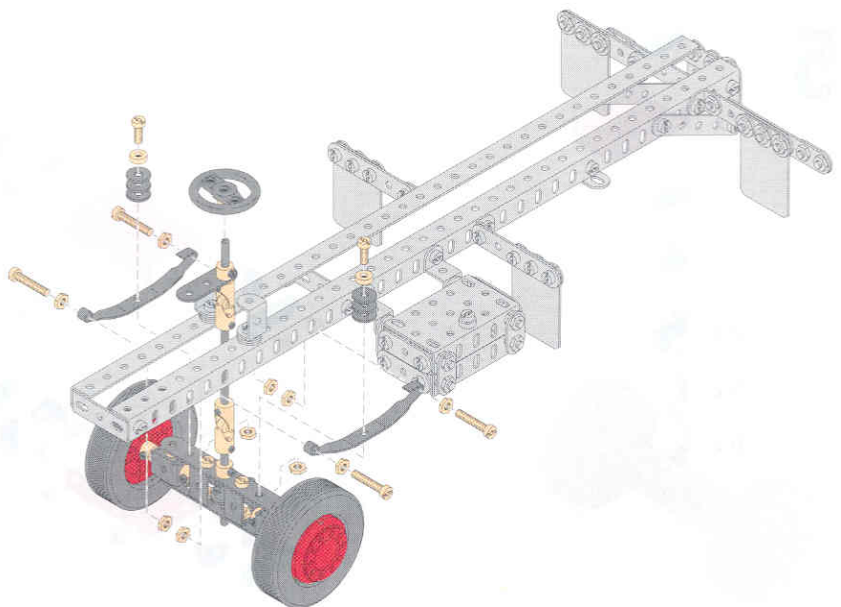



8

- 2 x 
- 1 x 
- 6 x 
- 2 x 
- 2 x 
- 4 x 





# 9

- 2 x 
- 2 x  150 mm
- 8 x 
- 8 x 
- 12 x 
- 12x 
- 2x 
- 2x 

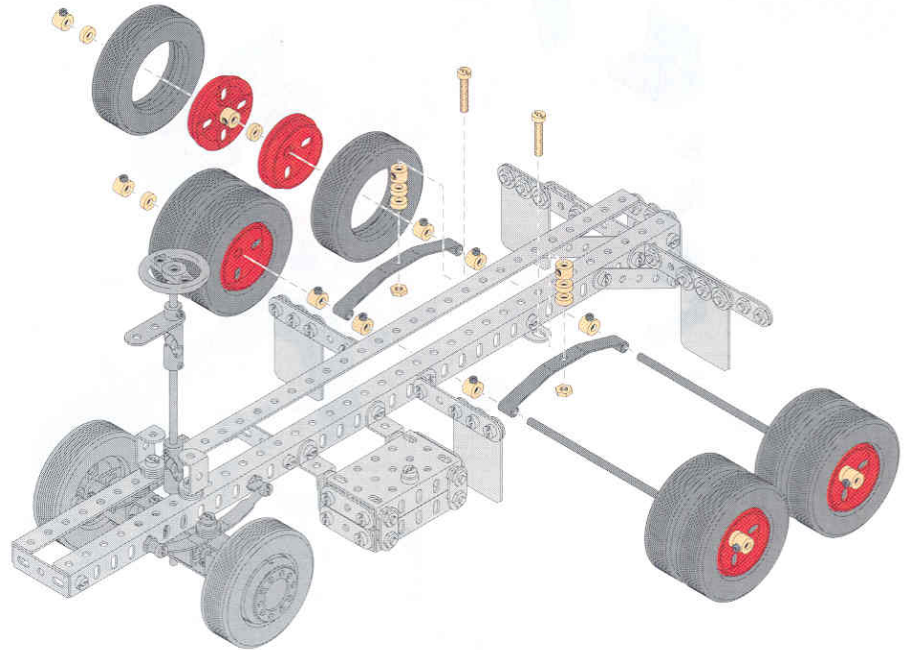

# 10

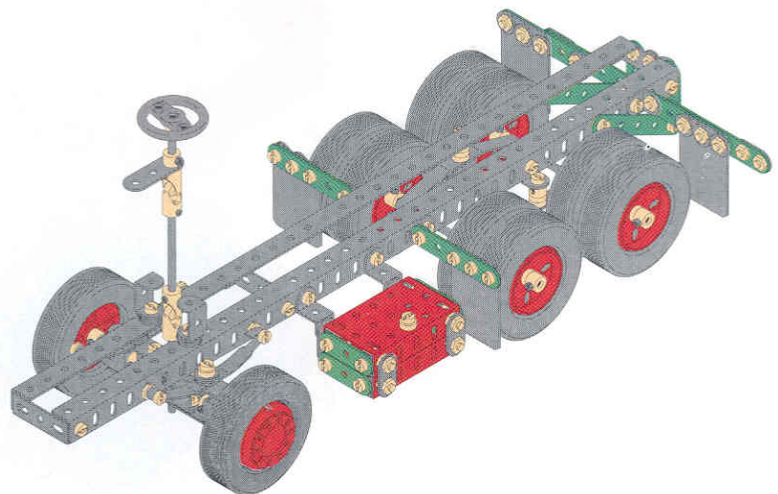

# 11

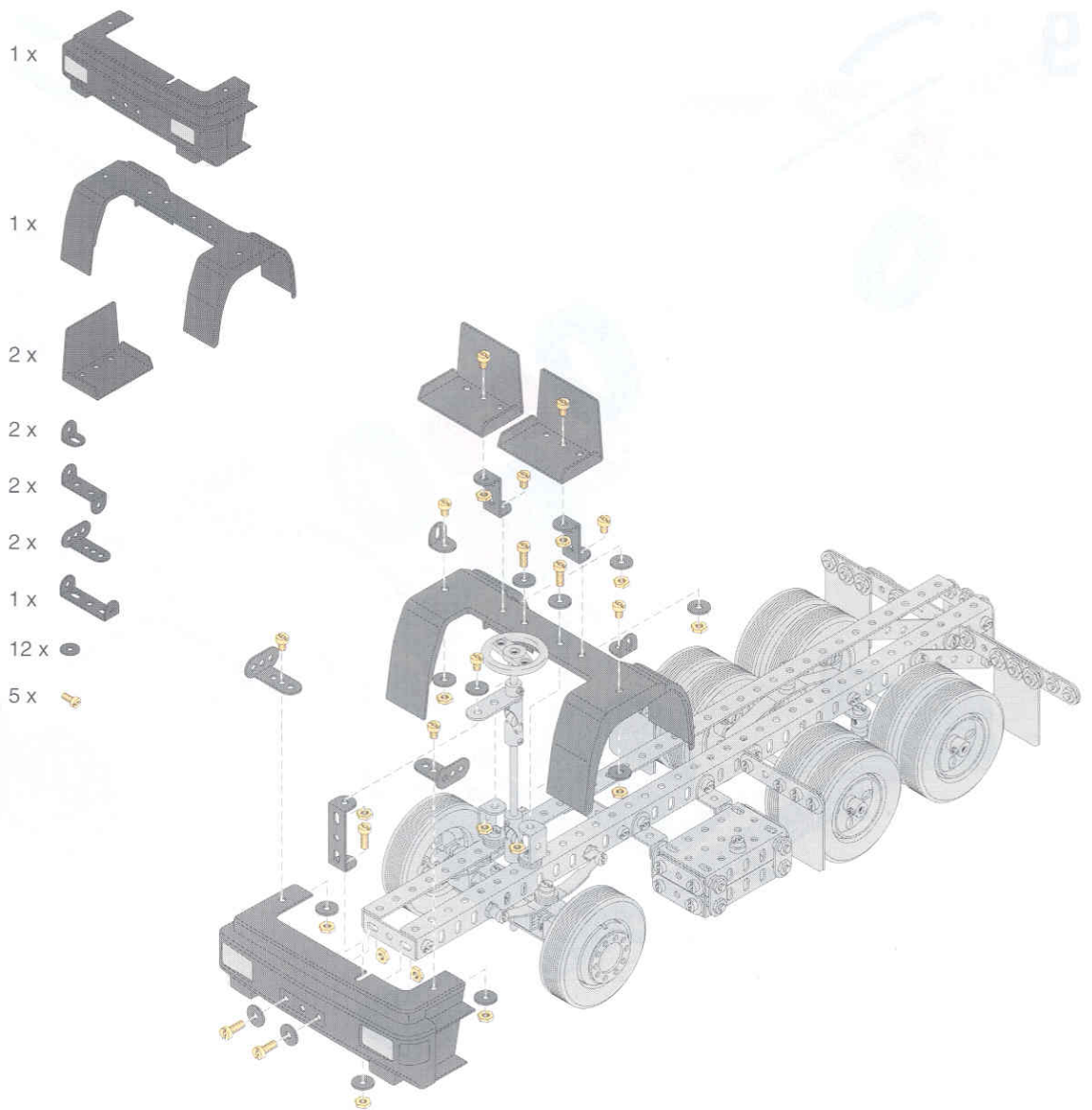

# 12

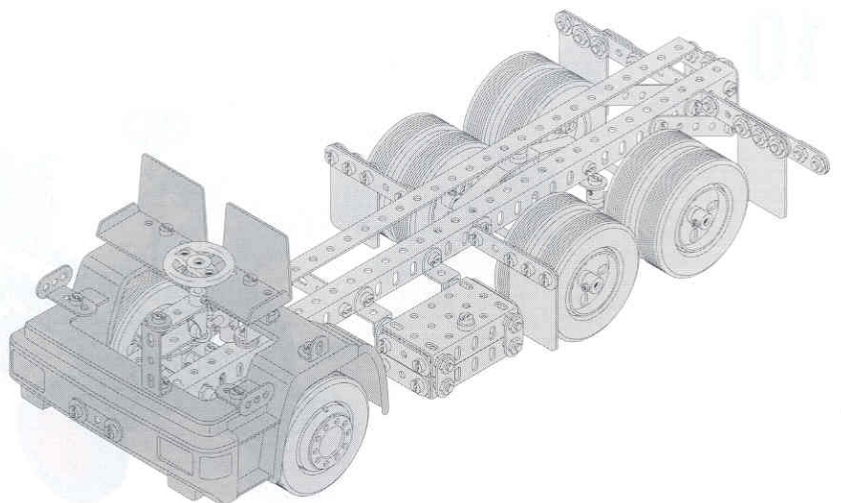



# 13

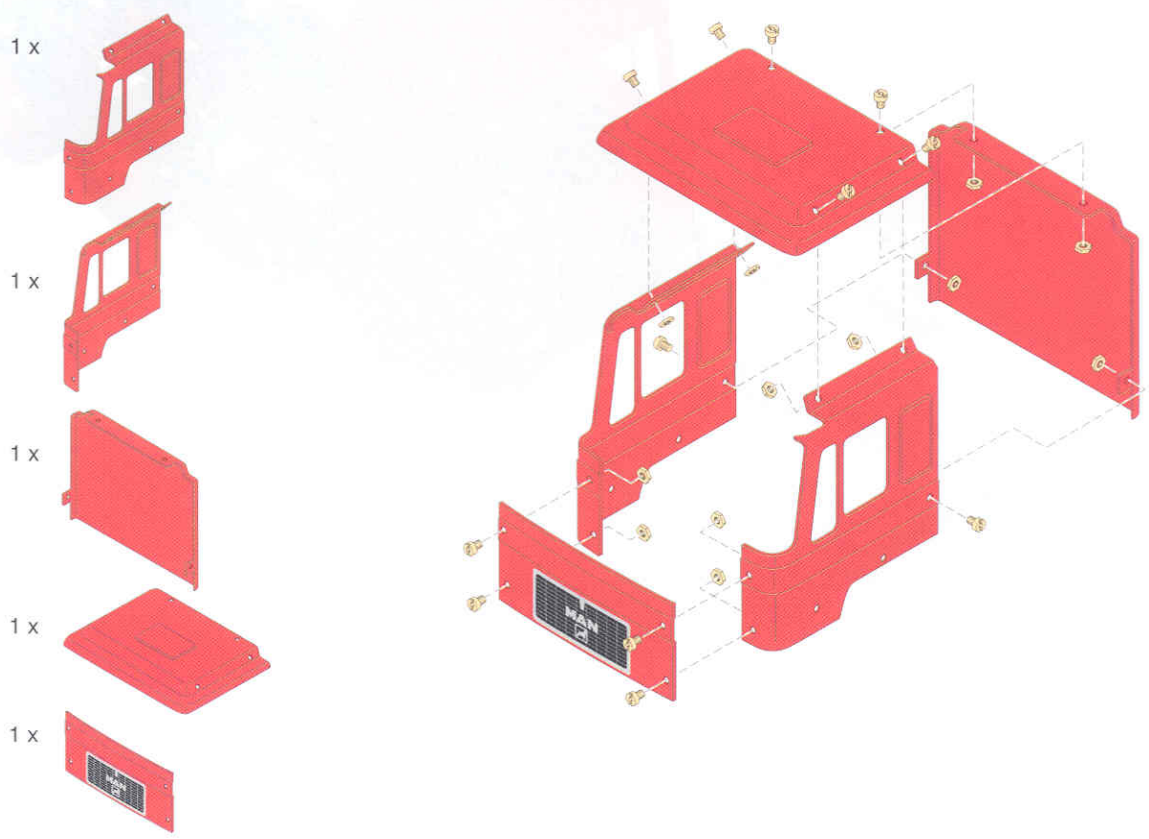

# 14

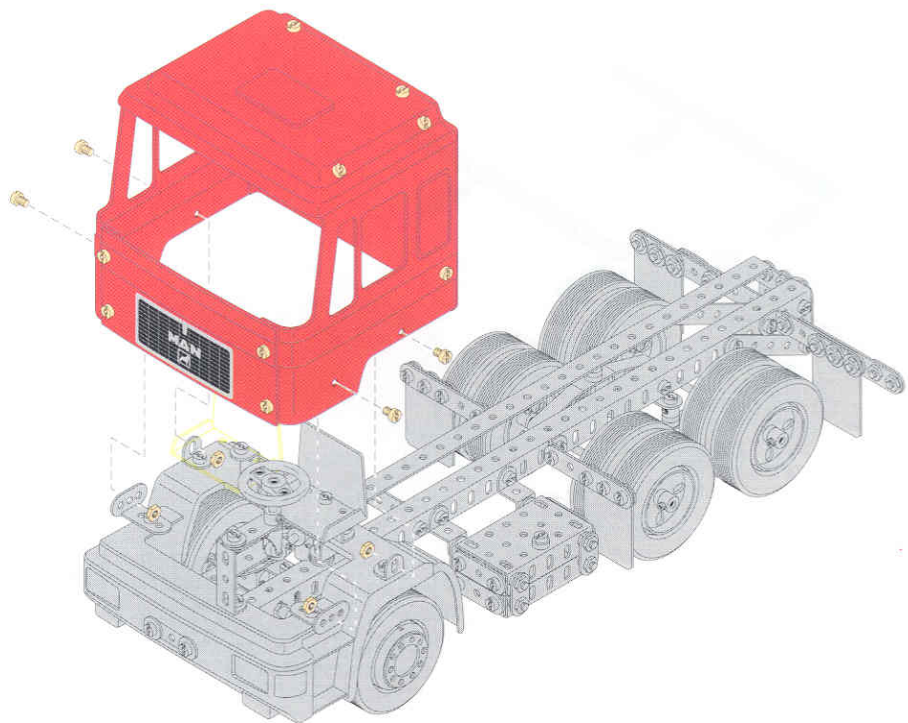

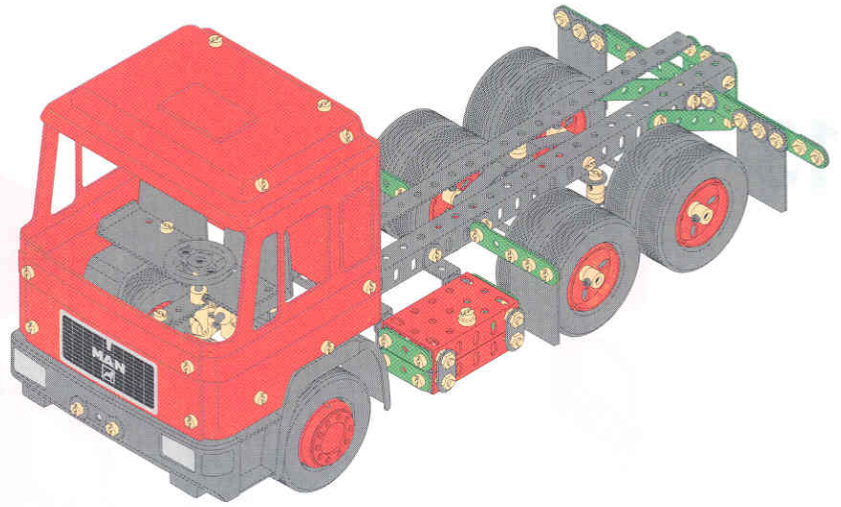



# Pritschenwagen

Flatbed Unimog truck · Camion-plateau  
Wagen met open laadvloer

# 1

3 x



2 x



4 x

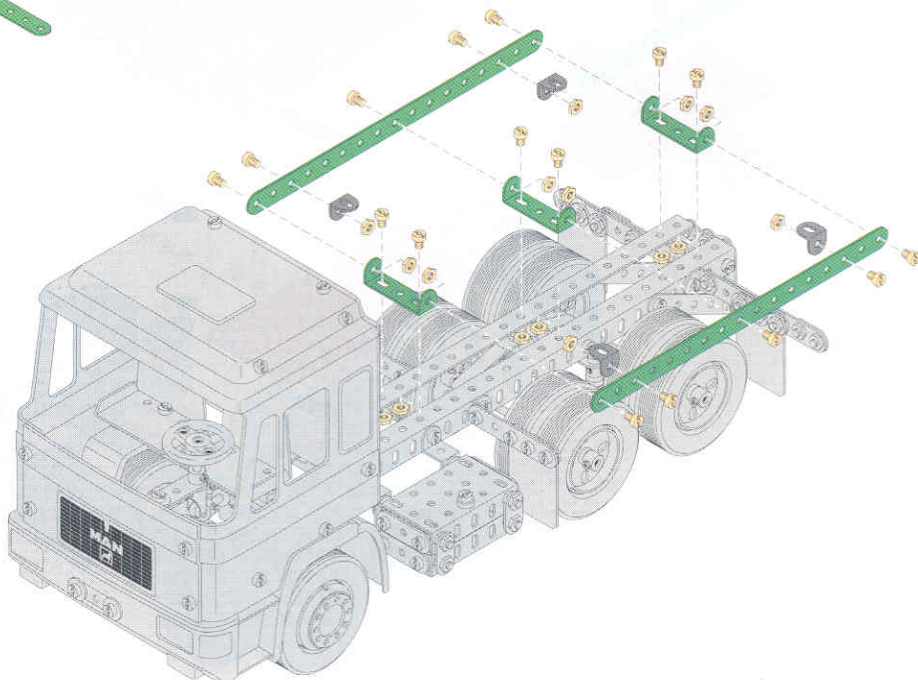

# 2





4 x

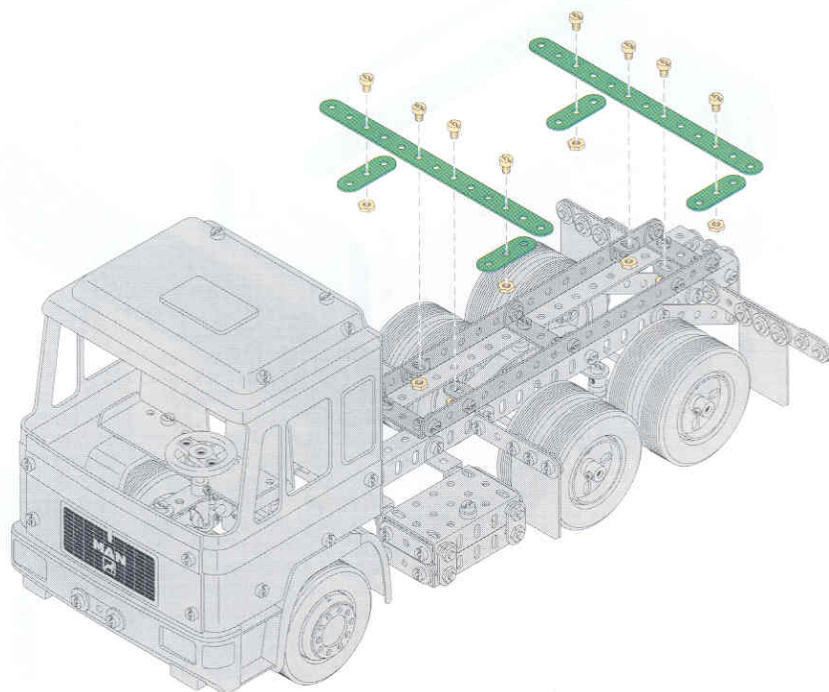

2 x



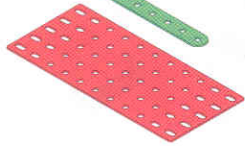

# 3

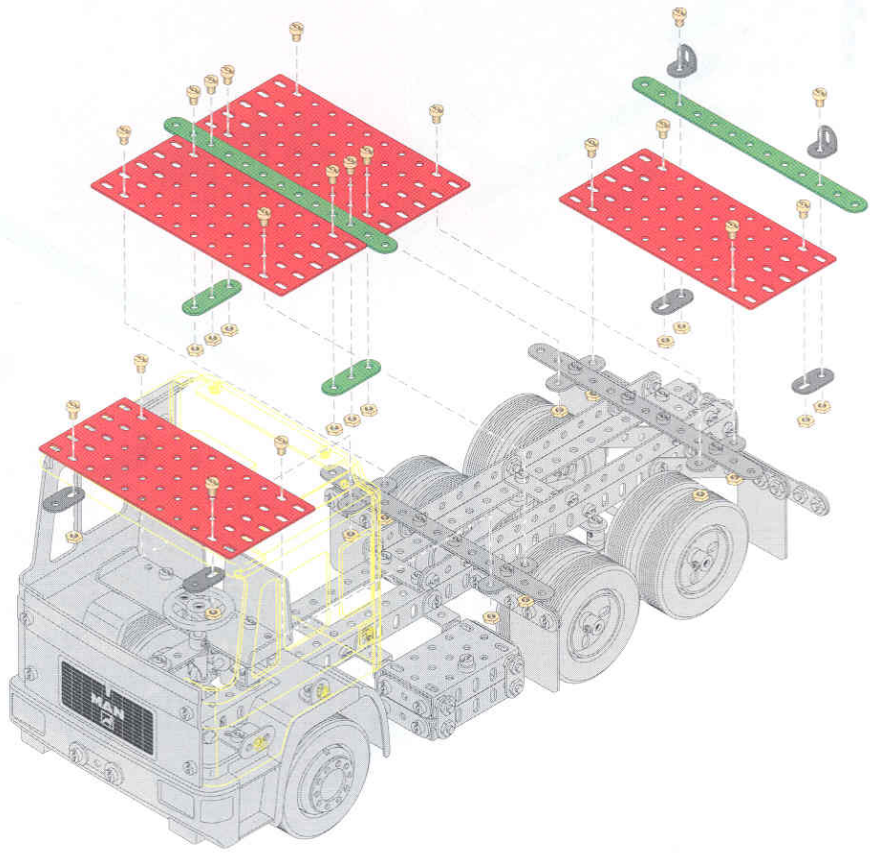
- 2 x 
- 4 x 
- 2 x 
- 2 x 
- 4 x 

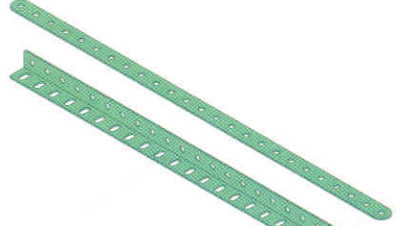
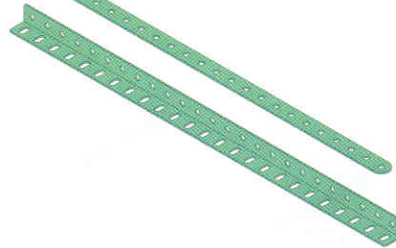

# 4

- 4 x 
- 8 x 
- 6 x 
- 2 x 

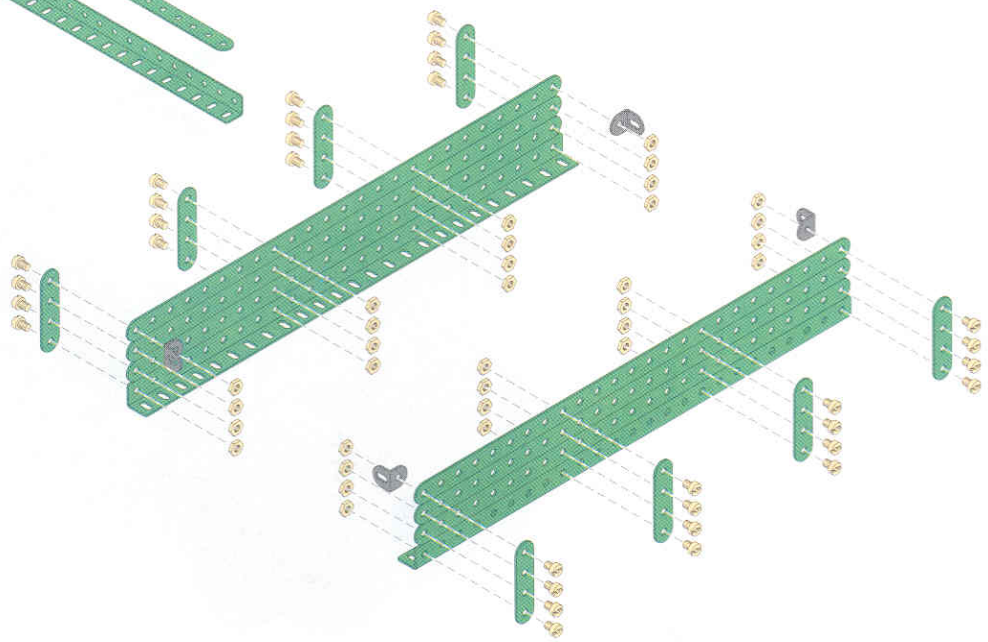



5

- 6 x
- 7 x
- 1 x

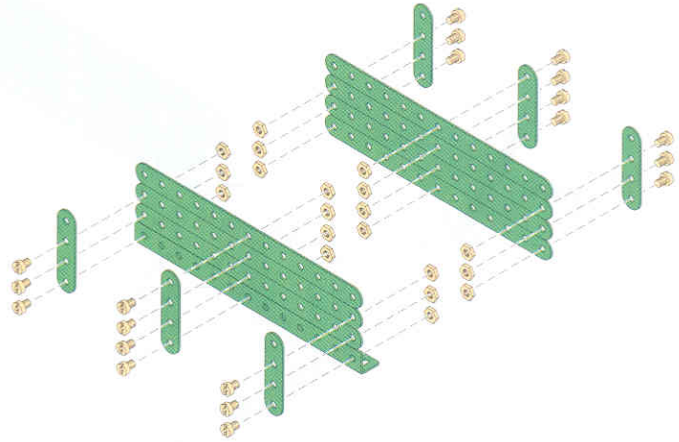

6

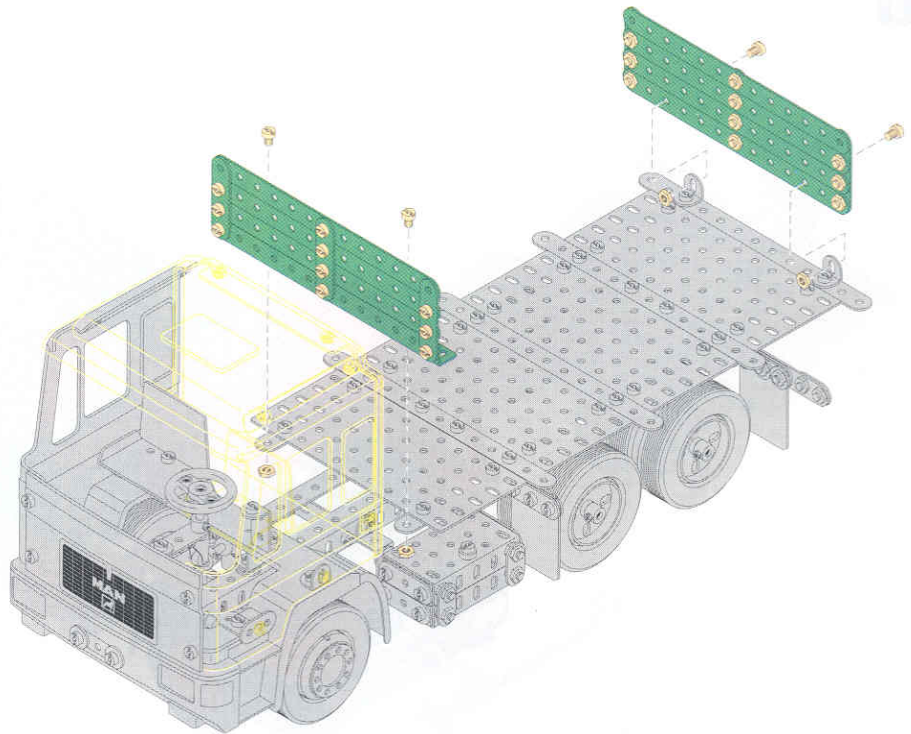

7

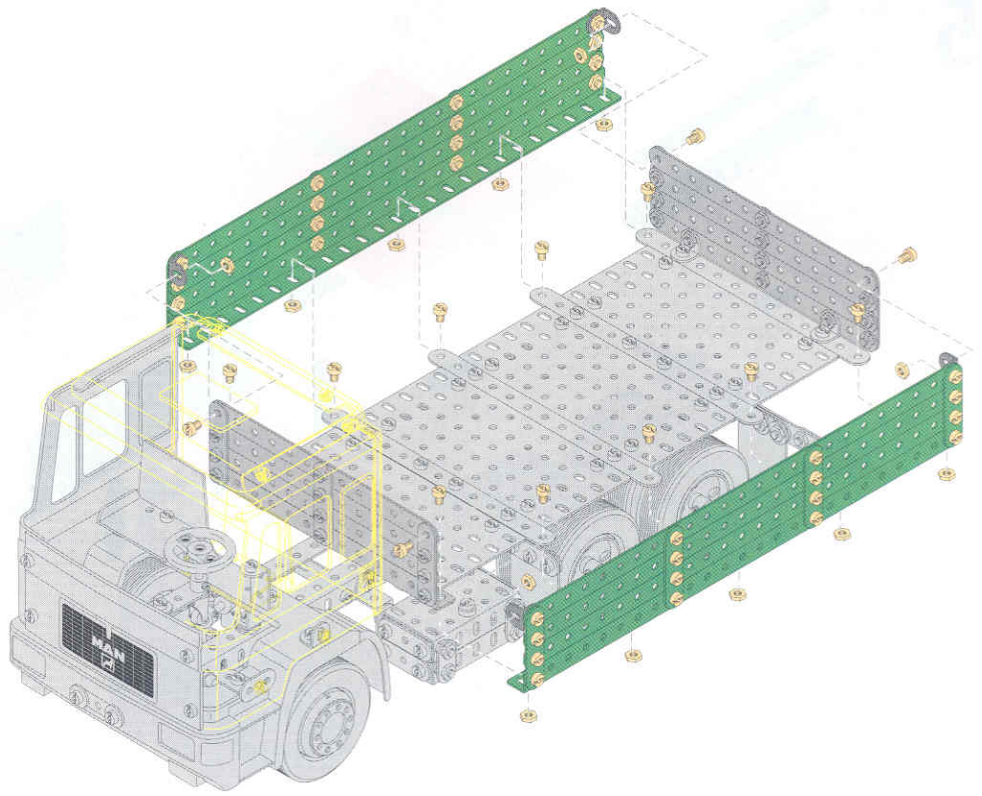

8

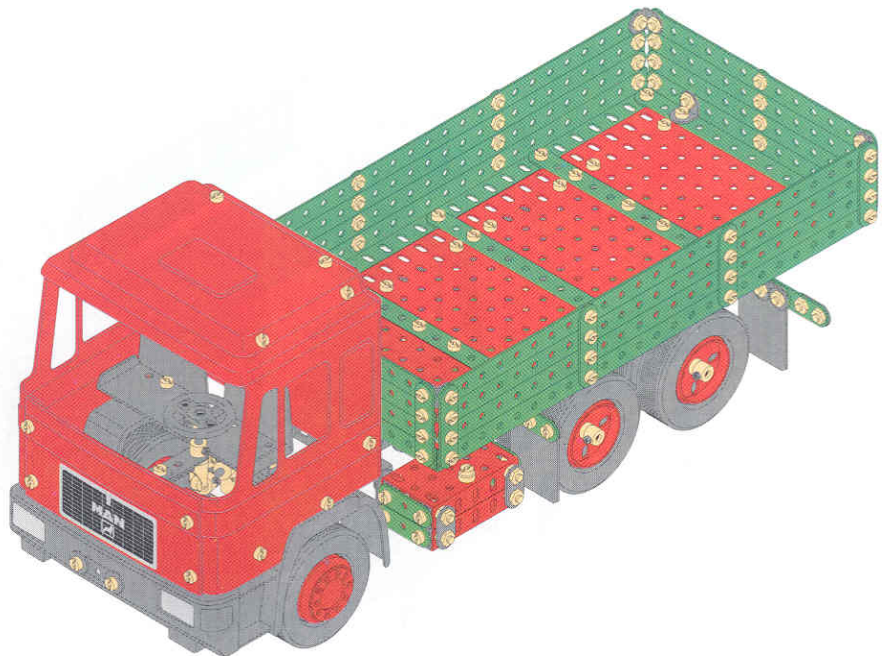



# Kipper

Dump Truck - Camion-benne  
Kiepwagen

## 1



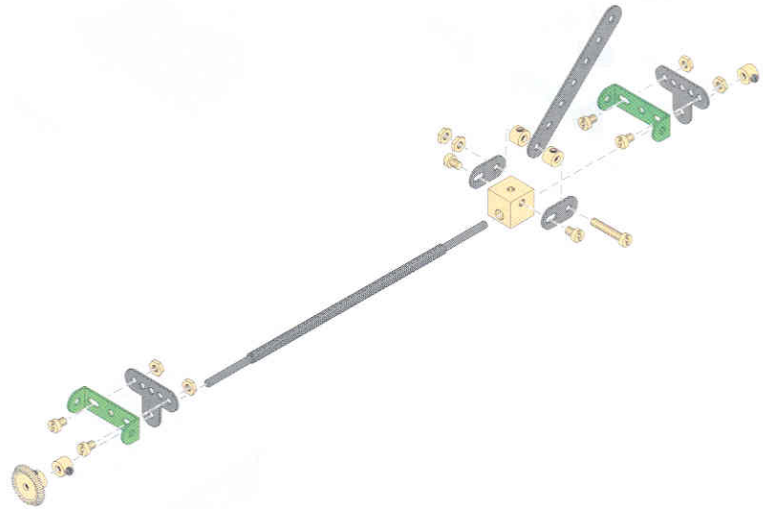

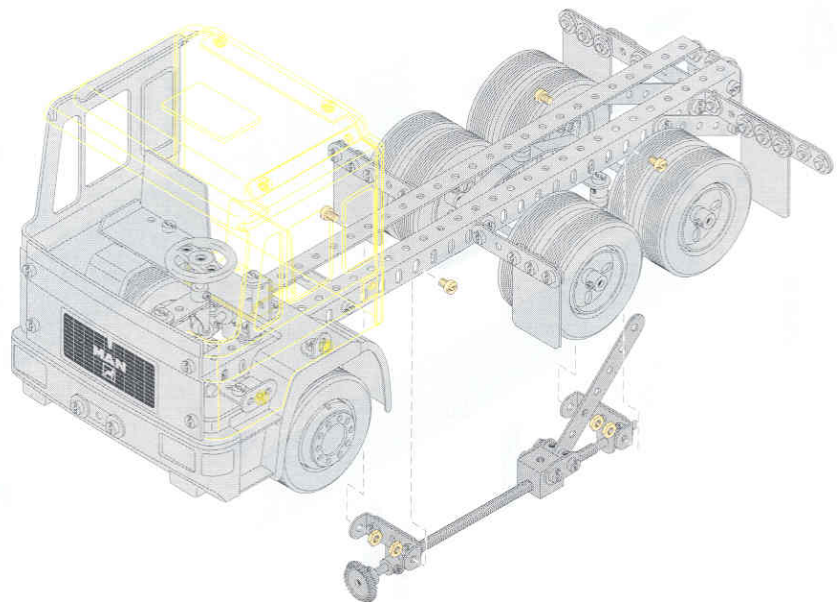

- 2 x
- 1 x
- 1 x
- 1 x
- 1 x
- 2 x
- 2 x
- 2 x
- 2 x
- 1 x



## 2





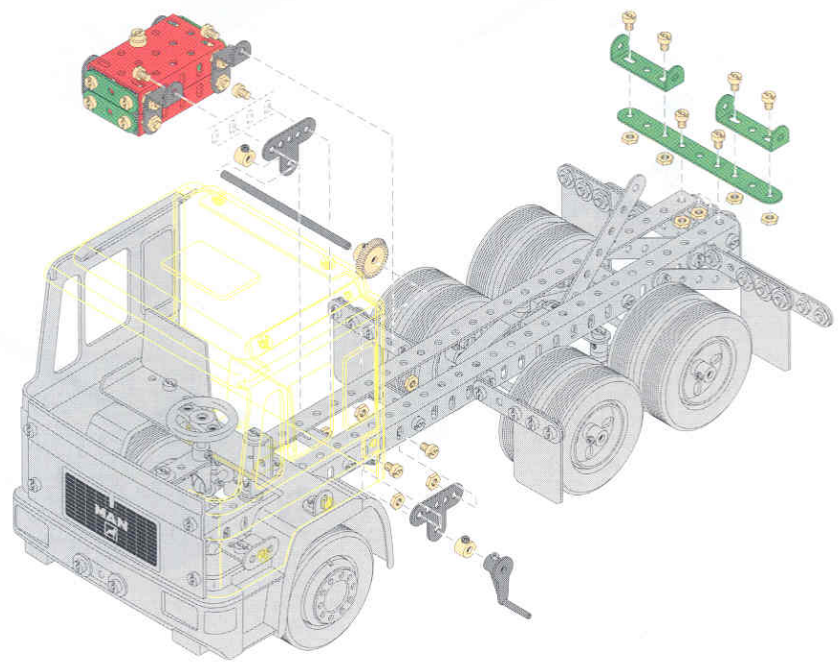

# 3

- 2 x 
- 1 x 
- 1 x  90 mm
- 1 x 
- 1 x 
- 2 x 
- 2 x 





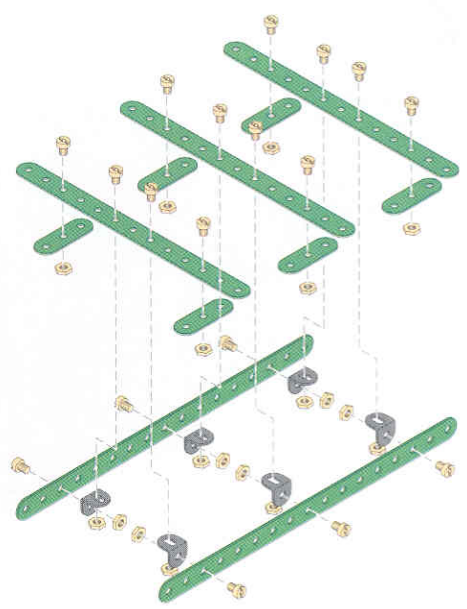

# 4

- 6 x 
- 3 x 
- 2 x 
- 6 x 





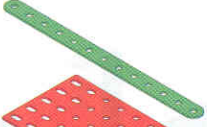

# 5

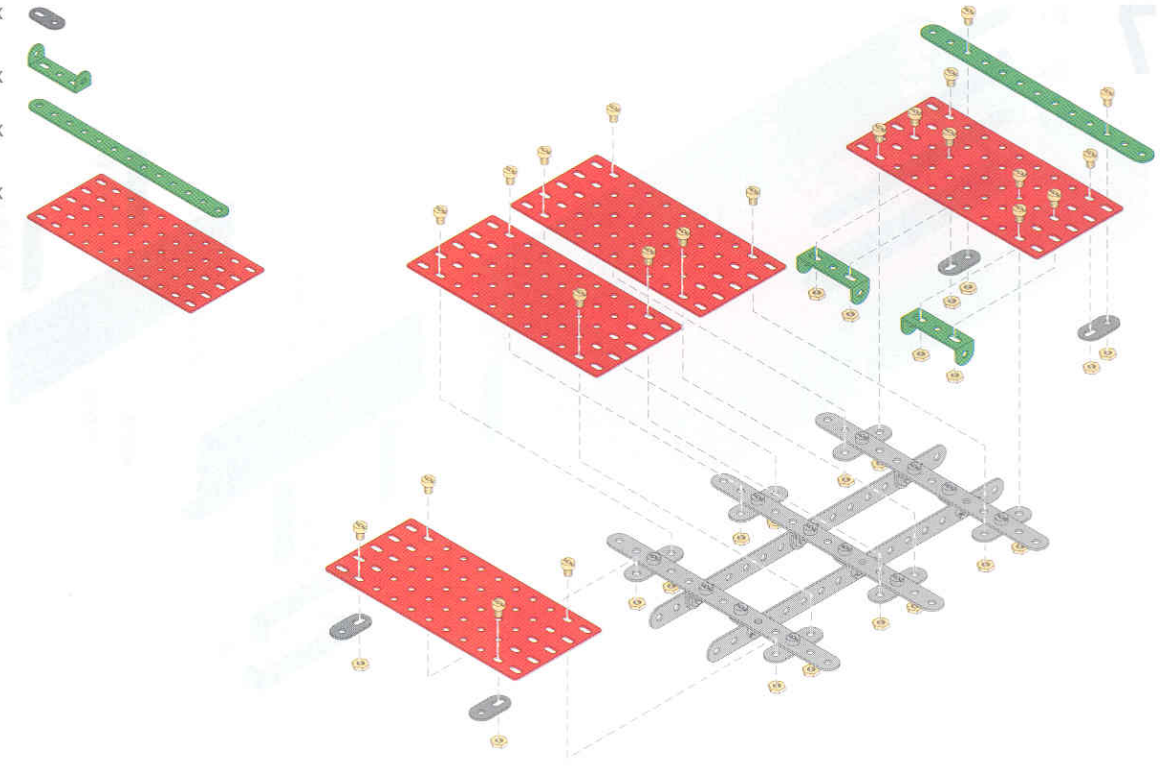
- 4 x 
- 2 x 
- 1 x 
- 4 x 

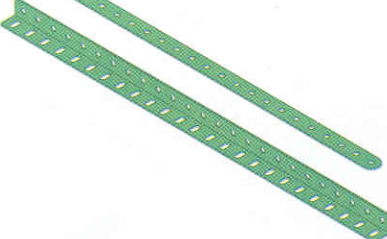

# 6

- 4 x 
- 8 x 
- 6 x 
- 2 x 

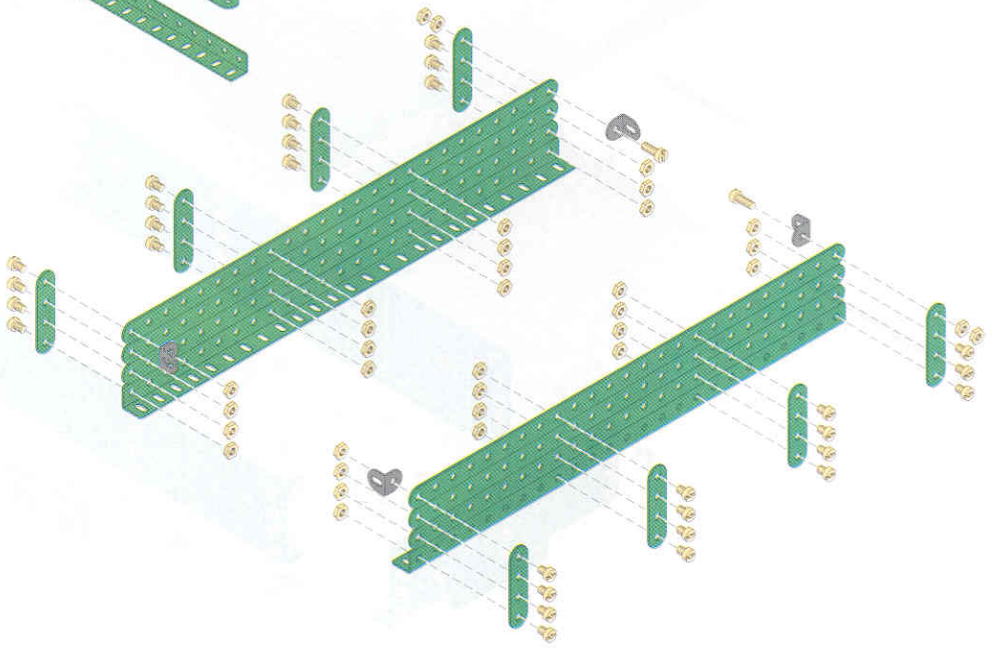

7

6 x

2 x

7 x

1 x

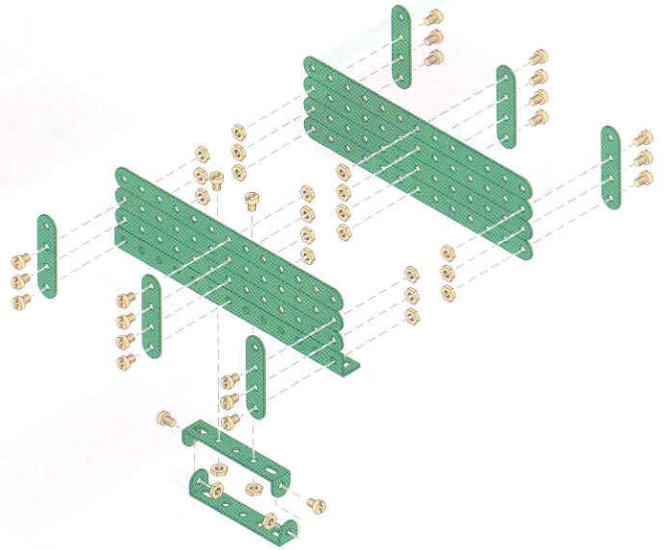
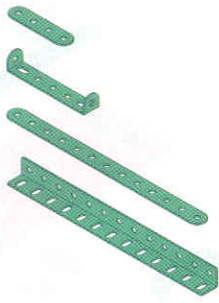

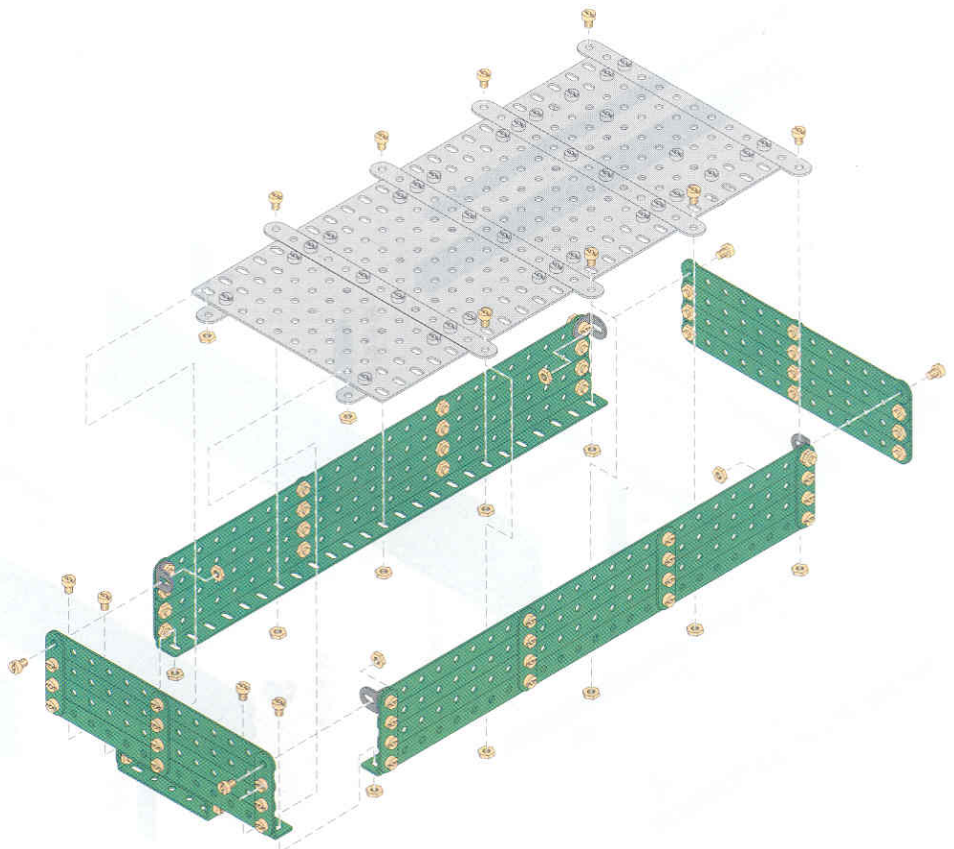

8

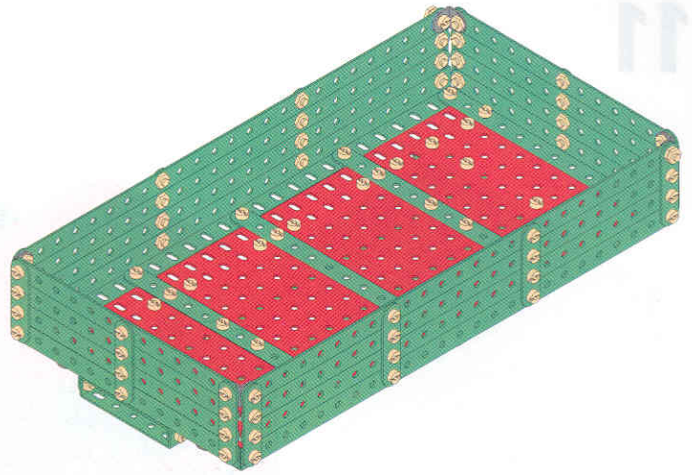

9



10

- 1 x  60 mm
- 1 x  150 mm
- 4 x 

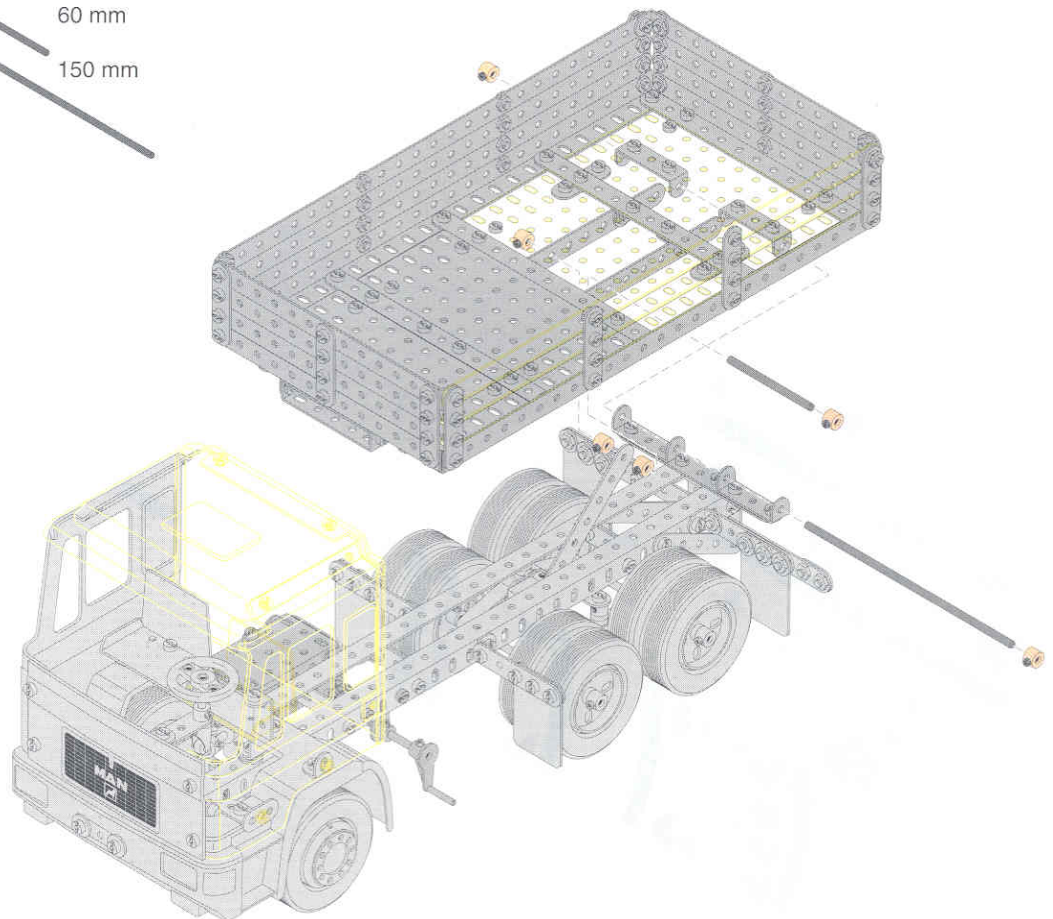





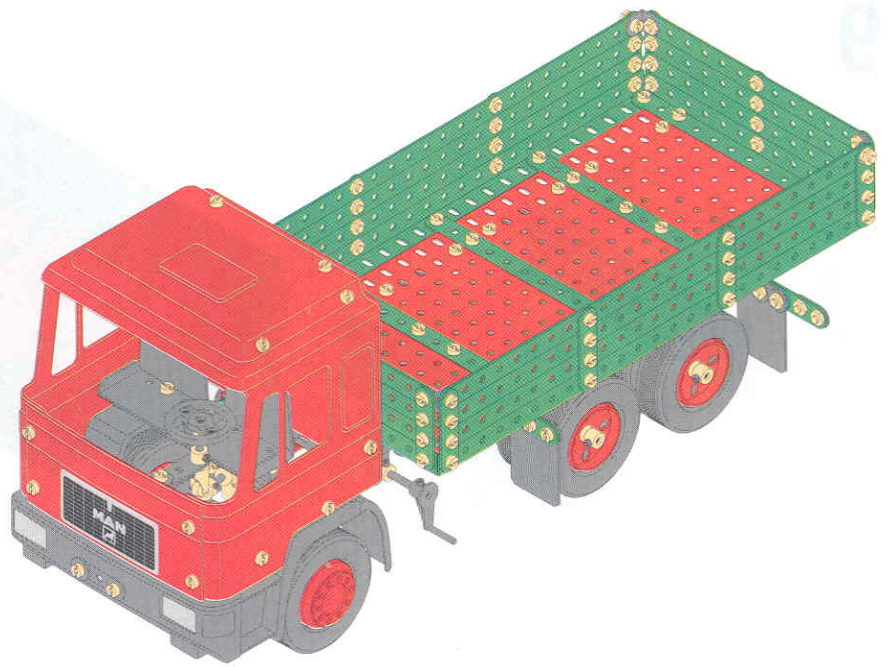

11



# Schneeräumer



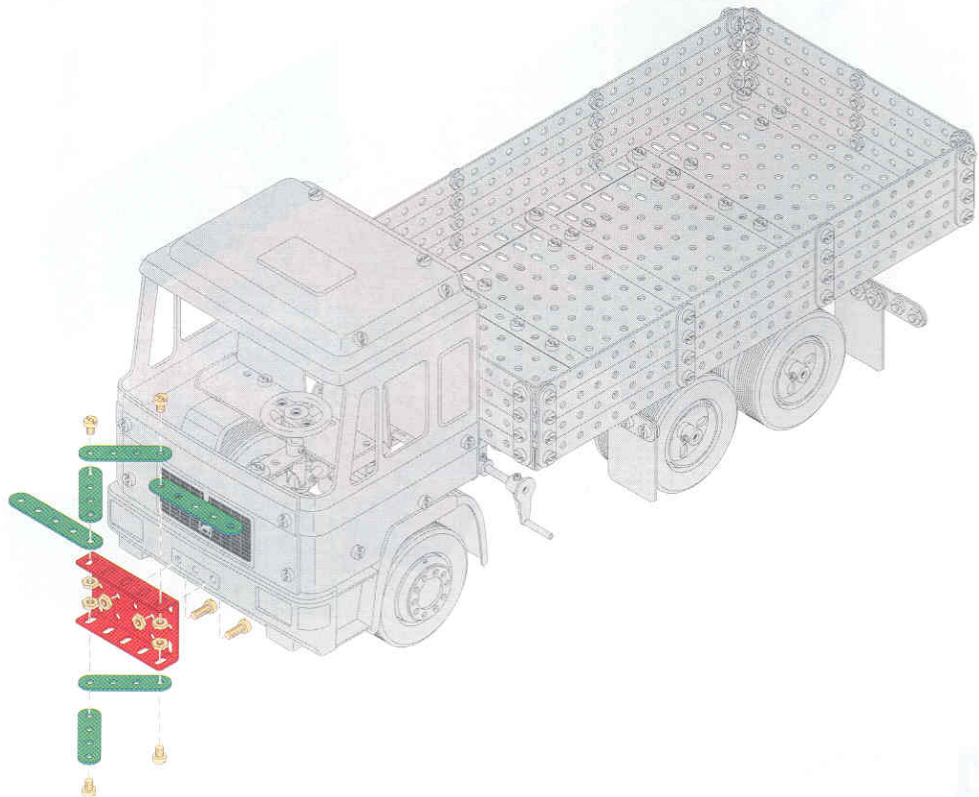

Snow plow • Chasse-neige  
Sneeuwruimer

## 1

- 4 x 
- 2 x 
- 1 x 
- 2 x 



## 2

- 2 x 
- 4 x 
- 2 x 
- 4 x 
- 16 x 

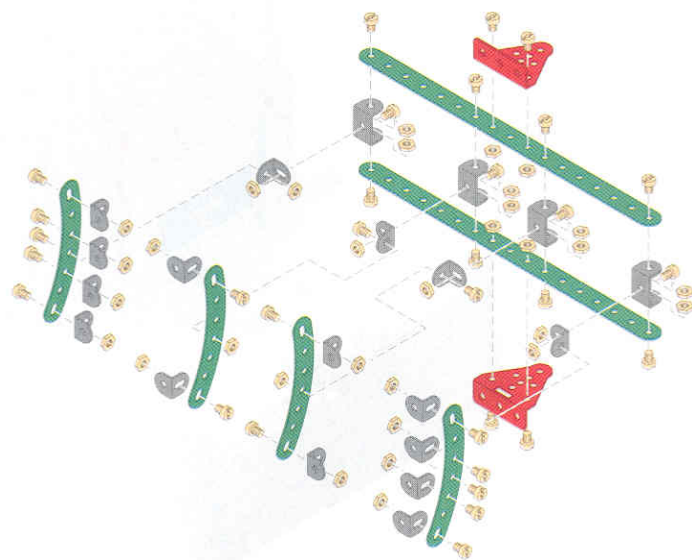



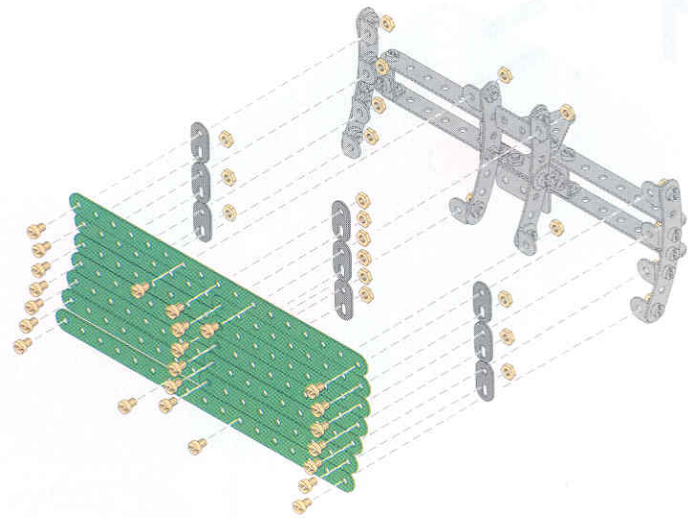

**3**

- 2 x 
- 10 x 
- 9 x 



**4**

- 1 x  60 mm
- 1 x  70 mm
- 2 x 
- 1 x 

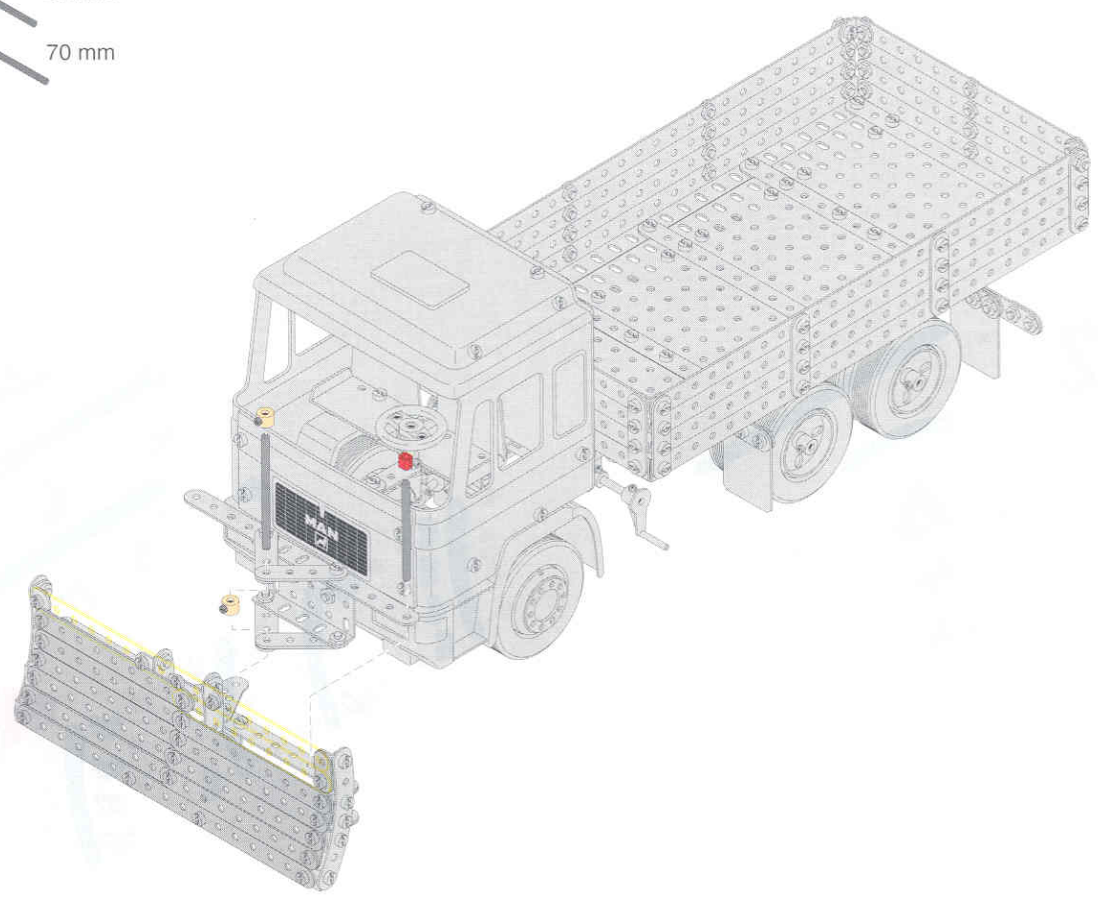



# 5

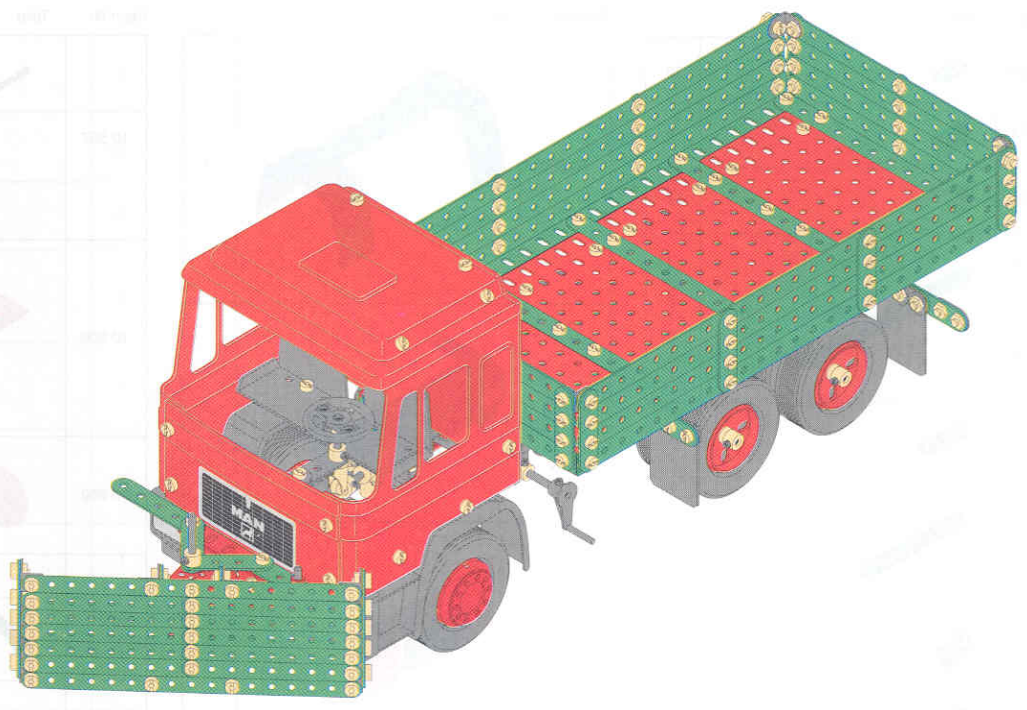

# Inhalt des Märklin-Metall-Baukastens

Contents of the Märklin Metall Construction Set  
 Contenu de boîtes Märklin Metall  
 Inhoud van de Märklin Metall-bouwdoos

















Sach-Nr.	Teile	
10 000		22
10 001		9
10 002		44
10 003 10 004 10 005 10 009 10 017 10 025 10 163		14 18 8 11 6 6 12
10 008		1
10 012		4
10 040		2
10 042		2
10 055		2
10 065 10 067		6 2
10 068		4
10 113 10 125		1 2
10 140		2
10 203 10 204 10 205 10 206 10 207 10 209 10 215		1 2 1 3 1 1 3
10 336		10

Sach-Nr.	Teile	
10 500		1
10 501		1
10 502		1
10 503		1
10 504		1
10 505		1
10 506		1

Sach-Nr.	Teile	
10 507		1
10 508		4
10 509		2
10 510		2
10 511		2
10 512		2
10 513		4
10 831		2
11 060		32
11 138		2
11 148		1
11 305		3
11 607		4
11 632		2

# Inhalt des Märklin-Metall-Baukastens

Contents of the Märklin Metall  
Construction Set  
Contenu de boîtes Märklin Metall  
Inhoud van de Märklin Metall-bouwdoos

Sach-Nr.	Teile	
11 717		2
11 727		36
11 728		17
11 763		2
11 764		4
11 793		2
12 400		1
14 006		1
14 007		2
14 010		340
14 027		10
14 200		1
14 202		300
14 203		13
14 204		9
14 223		39
57 919		1



Objekt Item Objet Bouwdoos	Anzahl der Teile Number of parts Nombre de pièces Aantal onderdelen	Technik mit Köpfchen Technology with brains Technique des petites têtes Techniek voor beginners en gevorderden
<b>1003</b> Grundkasten m 10 Basic Set m 10 Coffret de base m 10 Basisdoos m 10	208	<p>Einstieg in die Konstruktionswelt von märklin metall. Grundtechniken des Metallbaukasten-Systems. Entry into the construction world of märklin metall. Basic techniques of the metal construction set system. Introduction dans l'univers de la construction Märklin Métal. Techniques de base du système de jeu de construction métallique. Instap in de constructiewereld van Märklin metall. Basistechnieken van het constructiebouw-systeem.</p>
<b>1004</b> Grundkasten m 30 Basic Set m 30 Coffret de base m 30 Basisdoos m 30	342	<p>Umfangreicher Grundkasten für junge Einsteiger. Die spielerische Einführung in die Welt der Mechanik. Extensive basic set for young beginners. The fun introduction to the world of mechanics. Important coffret de base pour jeunes débutants. Introduction par le jeu au monde de la mécanique. Grote basisdoos voor de jonge beginners. Een speelse kennismaking met de wereld van de mechanica.</p>
<b>1005</b> Grundkasten m 50 Basic Set m 50 Coffret de base m 50 Basisdoos m 50	458	<p>Für Einsteiger mit größeren Ambitionen. Durch die Teilevielfalt sind eigene Ideen leicht umsetzbar. For beginners who want a challenge. The many parts allow you to build models of your own design. Pour débutants ambitieux. La variété des pièces permet de réaliser facilement ses propres idées. Voor beginners met grote ambities. Dankzij de grote verscheidenheid aan onderdelen zijn eigen ideeën gemakkelijk te realiseren.</p>
<b>1006</b> Grundkasten m 60 Basic Set m 60 Coffret de base m 60 Basisdoos m 60	664	<p>Für den fortgeschrittenen Metallbaukasten-Konstrukteur. Zum Bau von imposanten Modellen mit ausgefeilten Funktionen. For the advanced metal construction set builder. For building impressive models with extensive functions. Pour constructeur de jeu métallique chevronné. Pour montage de maquettes imposantes au fonctionnement perfectionné. Voor de gevorderde constructiebouwer. Voor de bouw van imposante modellen met specifieke functies.</p>
<b>1015</b> Ergänzungskasten E 10 Extension Set E 10 Coffret complémentaire E 10 Uitbreidingsdoos E 10	152	<p>Erweitert den Inhalt des Grundkastens 1003 auf den Inhalt von 1004. Der tiefere Einstieg in die Welt der Mechanik. Expands the contents of the basic set 1003 to the contents of 1004. A larger entry into the world of mechanics. Complète le contenu du coffret de base 1003 jusqu'à celui du 1004. Introduction approfondie dans le monde de la mécanique. Vergroot de inhoud van doos nr. 1003 tot die van nr. 1004. Een verdere stap in de wereld van de techniek.</p>
<b>1016</b> Ergänzungskasten E 30 Extension Set E 30 Coffret complémentaire E 30 Uitbreidingsdoos E 30	105	<p>Erweitert den Inhalt des Grundkastens 1004 auf den Inhalt von 1005. Für die gesteigerten Anforderungen an die Modelle. Expands the contents of the basic set 1004 to the contents of 1005. For more challenging models. Complète le contenu du coffret de base 1004 jusqu'à celui du 1005. Pour des maquettes aux exigences accrues. Vergroot de inhoud van doos nr. 1004 tot die van nr. 1005. Voor de bouw van grotere modellen.</p>
<b>1017</b> Ergänzungskasten E 50 Extension Set E 50 Coffret complémentaire E 50 Uitbreidingsdoos E 50	194	<p>Erweitert den Inhalt des Grundkastens 1005 oder 1010 auf den Inhalt von 1006. Zum Bau interessanter Groß-Modelle. Expands the contents of the basic set 1005 or the 1010 to the contents of 1006. For building interesting, large models. Complète le contenu du coffret de base 1005 ou 1010 jusqu'à celui du 1006. Pour construire d'intéressantes maquettes de grande taille. Vergroot de inhoud van doos nr. 1005 of 1010 tot die van nr. 1006. Voor de bouw van supermodellen.</p>
<b>1060</b> Ergänzungskasten Solar Extension Set Solar Coffret complémentaire Solar Uitbreidingsdoos Solar		<p>Mit diesem Ergänzungskasten und einem Grundkasten 1005, 1006, 1010 oder 1080 können verschiedene solarbetriebene Modelle gebaut werden. Different solar-powered models can be built with this extension set and a 1005, 1006, 1010 or 1080 basic set. Plusieurs modèles actionnés à l'énergie solaire peuvent être construits grâce à ce coffret complémentaire et à un coffret de base 1005, 1006, 1010 ou 1080. Met deze uitbreidingsset en een van de basissets 1005, 1006, 1010 of 1080 kunnen diverse modellen gebouwd worden die met zonne-energie aangedreven worden.</p>

Objekt Item Objet Bouwdoos	Anzahl der Teile Number of parts Nombre de pièces Aantal onderdelen	Technik mit Köpfchen Technology with brains Technique des petites têtes Techniek voor beginners en gevorderden
<b>1062</b> Ergänzungskasten Mechanik Extension Set Mechanics Coffret complémentaire Mécanique Themadoos Mechanica	142	<p>Ergänzt die Grundkästen 1005, 1006 und 1010 um einen leistungsstarken 12 Volt-Motor und viele Getriebebauteile wie Zahnräder, Ritzel und Schnecke zum Bau von motorisch angetriebenen Metallbaukastenmodellen. Spielerisch wird in das Thema "Antrieb und Getriebebau" eingeführt. Zur Versorgung kann jeder Märklin-Transformator verwendet werden.</p> <p>Expands the basic sets 1005, 1006 and 1010 to include a powerful 12 volt motor and many mechanism parts such as gear wheels, pinion gears and worm gears for the construction of motor-driven metal construction set models. The theme of propulsion and drive mechanism construction are introduced in a fun way. Any Märklin transformer can be used for power to the motor.</p> <p>Complète les coffrets de base 1005, 1006 et 1010 avec un moteur de 12 Volt et de nombreuses pièces d'engrenages telles que roues dentées, pignons et vis sans fin pour monter des maquettes de construction métallique motorisées. L'introduction à la question "Entraînement et montage d'engrenages" s'appuie sur le jeu. Pour l'alimentation, tous les transformateurs Märklin conviennent.</p> <p>Deze uitbreidingsdoos, afgestemd op de dozen nrs. 1005, 1006 en 1010, bevat een krachtige 12 Volt motor en een assortiment tandwielen, wormwielen en andere onderdelen – voor de bouw van motorisch aangedreven modellen. Spelenderwijs wordt kennis gemaakt met het thema "motoraandrijvingen". Voor de stroomvoorziening van de motor kan elke Märklin transformator gebruikt worden.</p>
<b>1080</b> Grundkasten m 100 Basic Set m 100 Coffret de base m 100 Basisdoos m 100	1454	<p>Umfangreichster Baukasten im Märklin Metallbaukasten-Sortiment. Neben dem hohen Lerneffekt beim Bau der Modelle kommt der vielfältige Spielspaß bei den verschiedenen Großmodellen nicht zu kurz. The largest set in Märklin metal construction set assortment. Building the different large models possible with this set provides a high degree of learning experience as well as all sorts of enjoyment. Plus grand coffret de construction de la gamme des coffrets de construction métallique de Märklin. Outre l'effet d'apprentissage important, lors de la construction des modèles, le plaisir du jeu n'est pas en reste avec les différents modèles grand format. Uitgebreide bouwdoos in het metalen-bouwdoosassortiment van Märklin. Behalve de hoge instructieve waarde bij de bouw van de modellen komt de speelpret bij de diverse grote modellen zeker niet te kort.</p>
<b>1081</b> Ergänzungskasten E 60 Extension Set E 60 Coffret complémentaire E 60 Uitbreidingsdoos E 60	795	<p>Erweitert den Inhalt des Grundkastens 1006 auf den Inhalt von 1080. Die neuen Bauvorschläge lassen das Herz eines jeden Metallbaukasten-Fans höher schlagen. Expands the contents of the 1006 basic set to the contents of the 1080. Metal construction set fans everywhere will be thrilled at the new suggestions for models. Elargit le contenu du coffret de base 1006 à celui du coffret 1080. Les nouvelles propositions de construction font battre plus vite le cœur de tout fan des coffrets de construction métallique. Breidt de inhoud van basisdoos 1006 uit tot de inhoud van 1080. De nieuwe bouwsuggesties doen het hart van elke metalen-bouwdoosfan sneller kloppen.</p>
<b>1083</b> Themenkasten Unimog Theme Set Unimog Coffret à thème Unimog Themadoos Unimog	860	<p>Fünf verschiedene Unimog-Modelle in je zwei Varianten können wahlweise gebaut werden. Die hohe Teileanzahl ist die Basis für vielfältige Eigenentwicklungen. Any one of five different Unimog (truck) models, each with two possible variations, can be built. The large number of parts in this set is the basis for all sorts of models that you design yourself. Il est possible de construire cinq modèles Unimog différents, chacun ayant deux variantes. Le grand nombre de pièces constitue la base de développements personnels variés. Vijf verschillende Unimog-modellen in elk twee varianten kunnen naar keuze gebouwd worden. Het grote aantal onderdelen is de basis voor veelvuldige zelfstandige ontwikkelingen.</p>
<b>1085</b> Themenkasten Lastkraftwagen "Truck" Theme Set Coffret à thème Camions Themadoos Vrachtwagen	1030	<p>Baukasten zum wahlweisen Erstellen von verschiedenen Lastkraftwagenvarianten. Das neue Führerhaus ist aus einzelnen Metallteilen zusammengesetzt. Construction set for building one of several different truck models. The new cab is assembled from individual metal parts. Coffret de construction pour la réalisation de différentes variantes de camions. Le nouveau poste conducteur est composé de différents éléments métalliques. Bouwdoos waarmee men naar keuze meerdere varianten van vrachtwagens kan maken. De nieuwe cabine is samengesteld uit losse metalen onderdelen.</p>



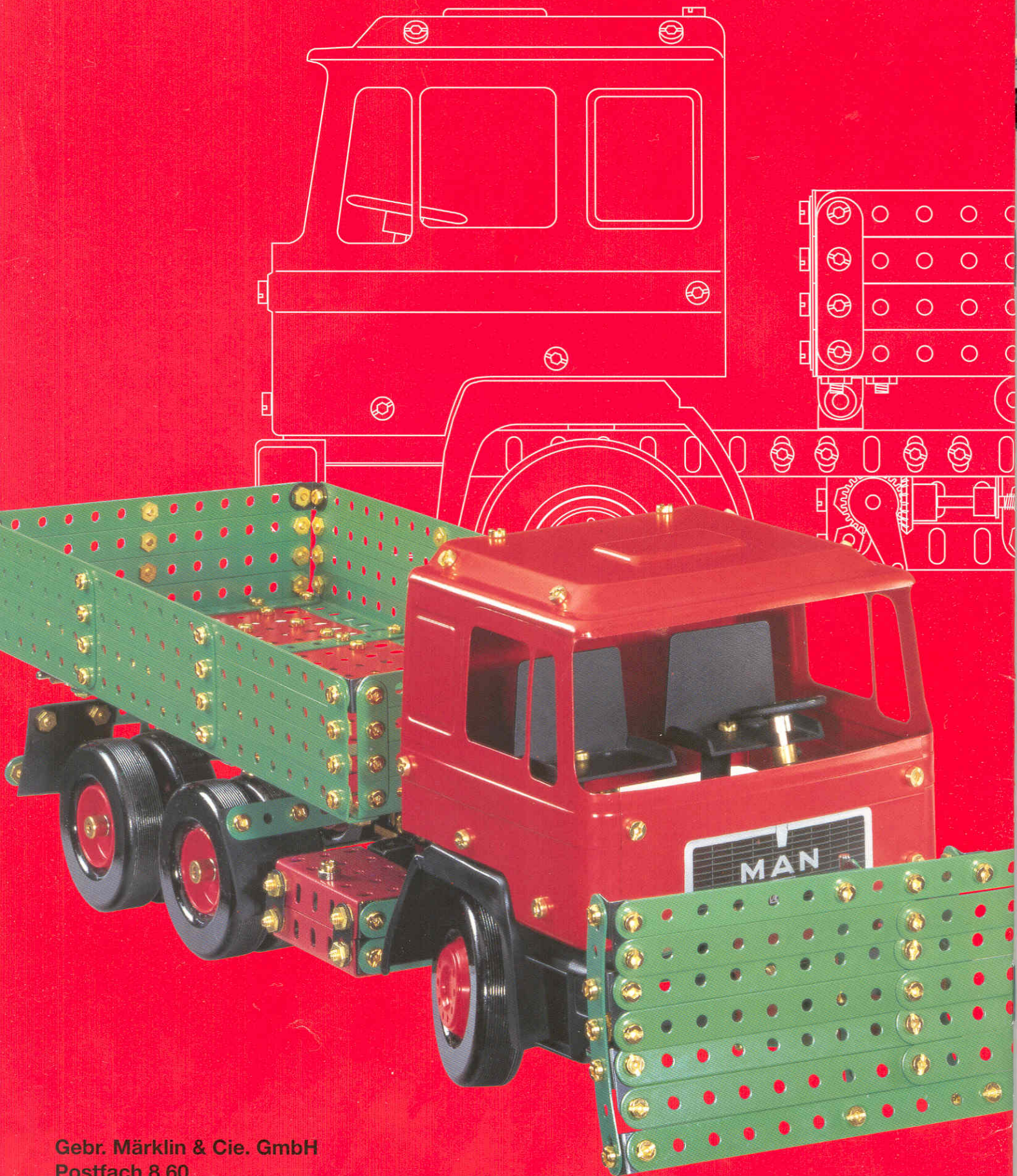

**Gebr. Märklin & Cie. GmbH**  
**Postfach 8 60**  
**D-73008 Göppingen**

Printed in Germany  
Imprimé en Allemagne  
Änderungen vorbehalten  
68 2270 Of 09 95 se